



Fracture – Acoustic Tile

Leadlight

acoufelt
making quiet

Product Detail

Product	Fracture acoustic tile
Surface	Wall
Composition	100% polyester
Material	FilaSorb™
Recycled Content	60% min.
Dimensions	600mm w x 300mm h
	Custom size available upon request
Thickness	12mm 0.47" +/- 10%
Tiles per box	18

Guarantees

Warranty against defects	20 Years*
Light Fastness Warranty	20 Years*
	*conditions apply

 QuickShip available

Technical Data

Fire Test Method Number	ISO 9705: 1993 Group 1 AS ISO 9705:2003 Group 1 ASTM E84-17a Class A
Indoor Air Quality	Low VOCs emission, formaldehyde and Phenol-free
Light Fastness	ISO 105-B02 1994, 6-7

Environmental Attributes

- Declare Certification
- LCB Red List Free
- Phenol And Formaldehyde Free
- Low VOC
- CDPH Compliance
- Complies with Building Standards



Declare.

Acoustic Performance

Sound Absorption ISO 354-2006 NRC 0.45

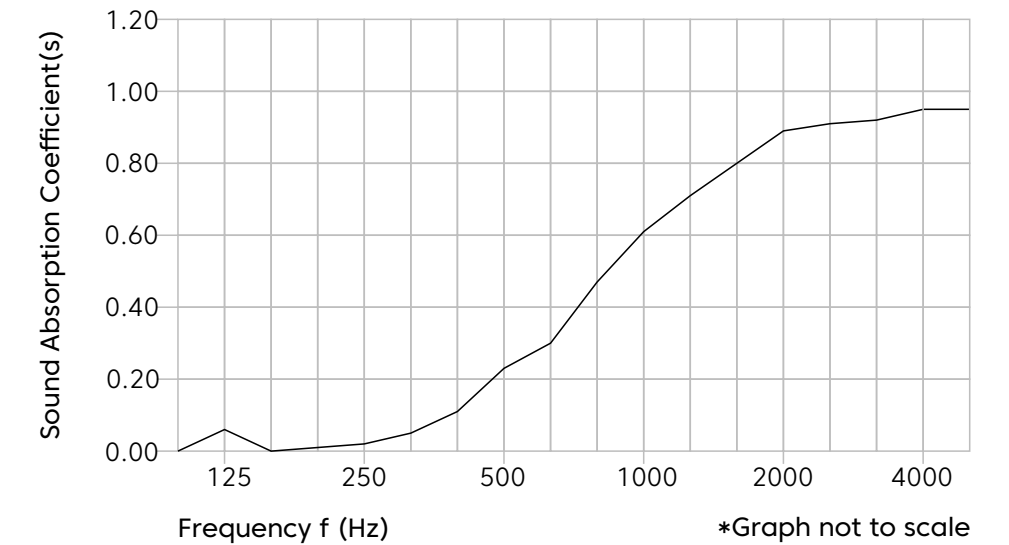

Frequency f (Hz)	125	250	500	1000	2000	4000	NRC
12mm a _s No Air Gap	0.06	0.02	0.23	0.61	0.89	0.95	0.45

Design

Elevation

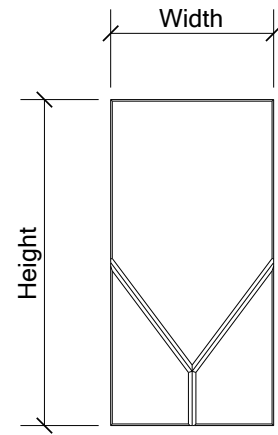

Perspective

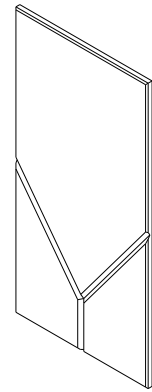

Recommended Layout

Layout 1

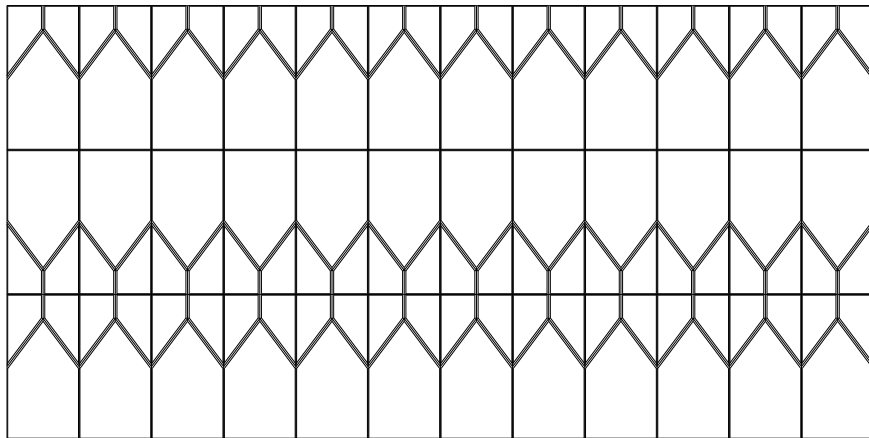

Layout 2

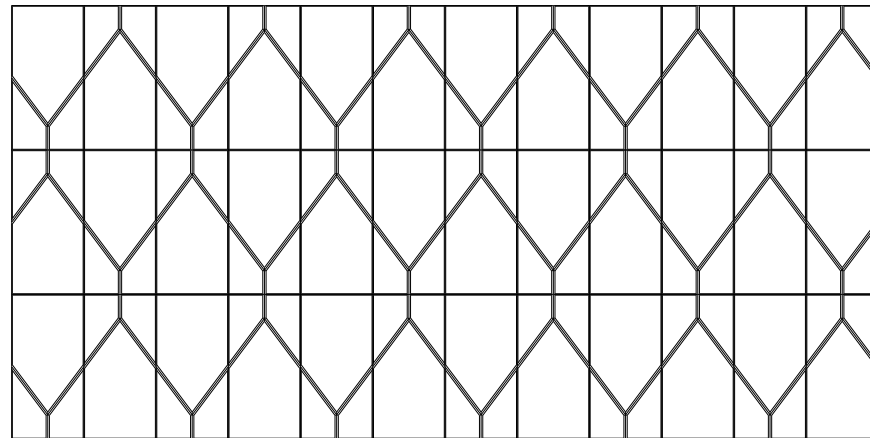

Layout 3

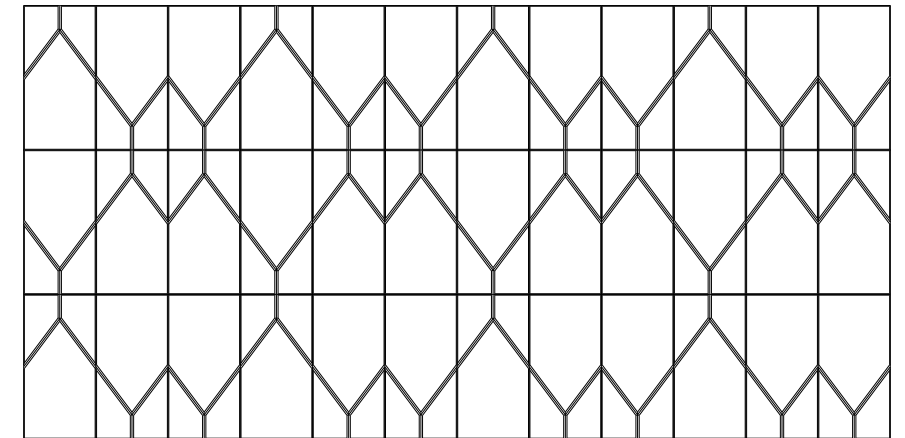

Mounting Methods

Adhesive Backing

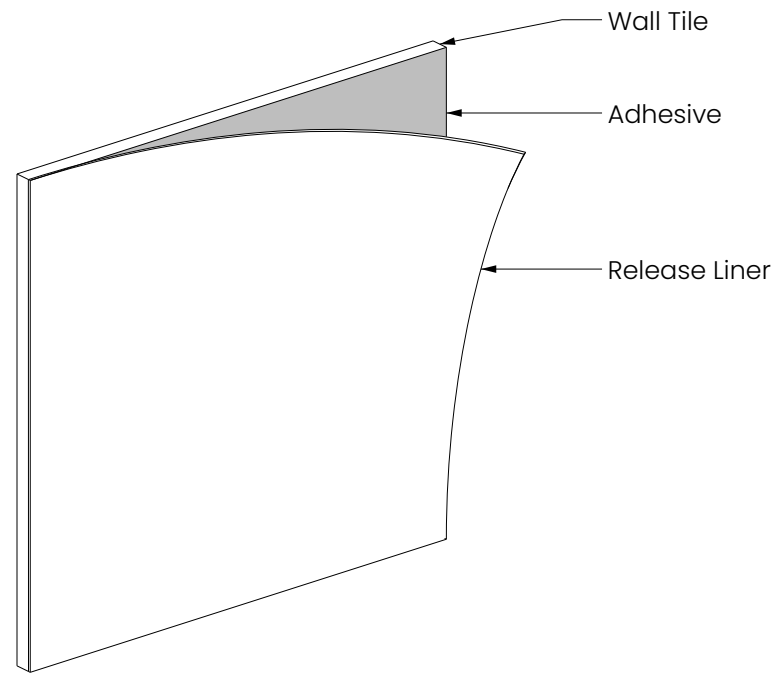

Construction Adhesive

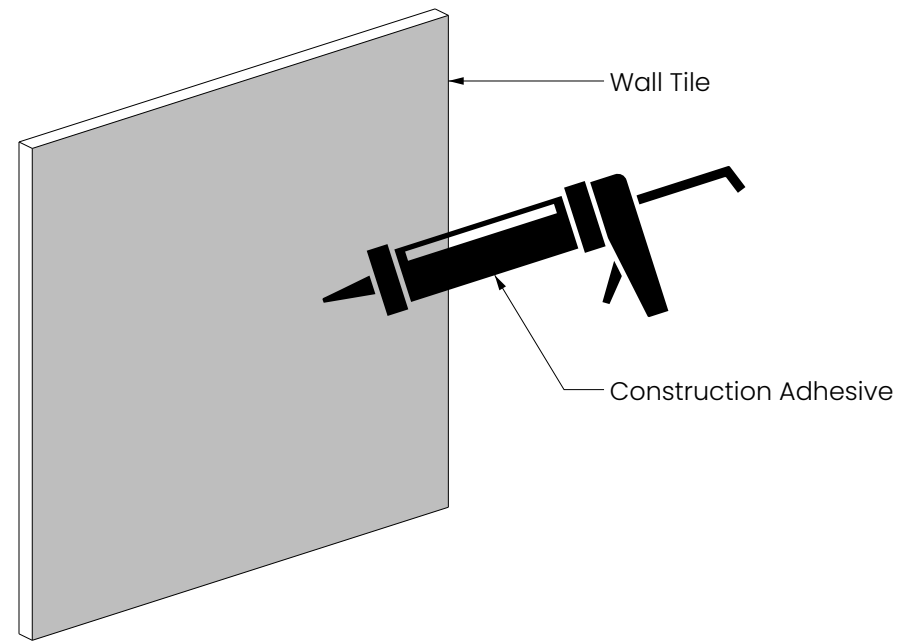

Z-Clip Mount

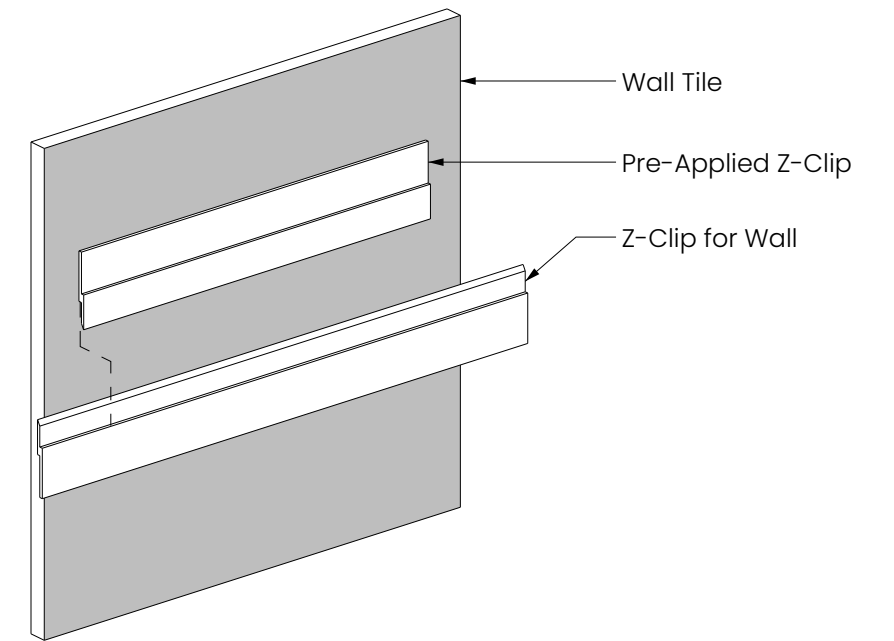

Colorways



Lipstick Red
LI14



Carrot
CA08



Butter
BU07



Popcorn
PO26



Pistachio
PI25



Wasabi
WA29



Thistle
TH28



Peacock
PE20



Oregano
OR18



Kale
KA12



Denim
DE09

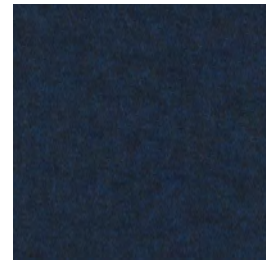

Midnight
MI16



Azur
AZ05



Marine
MA15

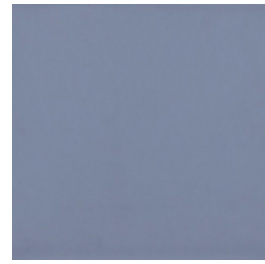

Periwinkle
PE23

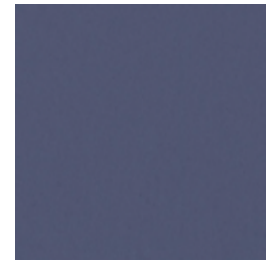

Iris
IR10



Berry
BE06

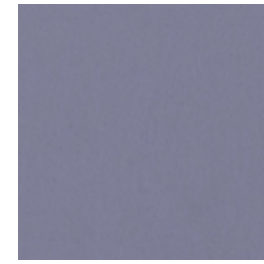

Lilac
LI13



Peach
PE19



Peppercorn
PE22

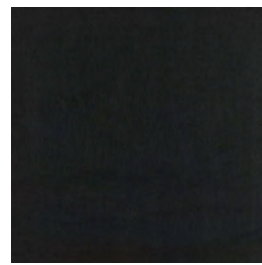

Piano Black
PI24



Charcoal
CH01

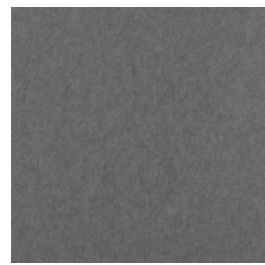

Slate
SL27



Grey
GR02



Metal
ME03



Platinum
PL04



White
WH12



Pearl
PE21



Ivory
IV11