

# SPACE DIVIDING SYSTEMS

WOVENIMAGE.COM

**wvi**  
WOVEN IMAGE®



WOVEN IMAGE®

## DESIGNED SPACE SOLUTIONS WITH ECHOPANEL®

Space dividers are the semi-permanent features, that assist in creating and organising open-plan spaces - be it the classroom, office or even in a restaurant. Woven Image® has designed a collection of modular dividing systems made from the leading opportune product - EchoPanel® - to achieve the important characteristics for such systems; including sound absorption and by being a lightweight, agile material.

By using EchoPanel®, the interior space maintains a sustainably responsible standard. EchoPanel® is the leading, specialised contract material with top level fire ratings, but at the core of its ethos is also dematerialisation and recycling. EchoPanel® is made from up to 60% post-consumer waste sourced from recycled PET bottles. Impressively, in 2015 alone, Woven Image® saved in excess of 283 tonnes of PET plastic from going to landfills, repurposing this waste for EchoPanel® products. It's no wonder, then, that EchoPanel® can secure maximum credits under GECA's Green Star sustainability rating tool, as administered by the Green Building Council Australia.

A conscious aesthetic is everything and EchoPanel® comes in the largest range of colour options for ceiling-suspended space dividers such as the Pendants (made from EchoPanel® 12MM & 24MM) and free-standing space dividers made from EchoPanel® 24MM. Newly released additions to the EchoPanel® 24MM range mean that there are more options than ever for classic Woven Image® products: Paling, Platoon and Wrap.

Aside from effectively and efficiently organising a space, the products in this brochure can be easily adapted to immediately improve the sound quality in a space where privacy or improved acoustics is desired. Free-standing space dividers can be configured around workstations or break-out areas, granting more privacy. Ceiling-suspended space dividers can be added to a hotel lobby or broad area restaurant space, where intelligently designed division and aesthetic is required.

For more information about the products in this brochure or EchoPanel®, please contact your Woven Image® Account Manager or visit us online.

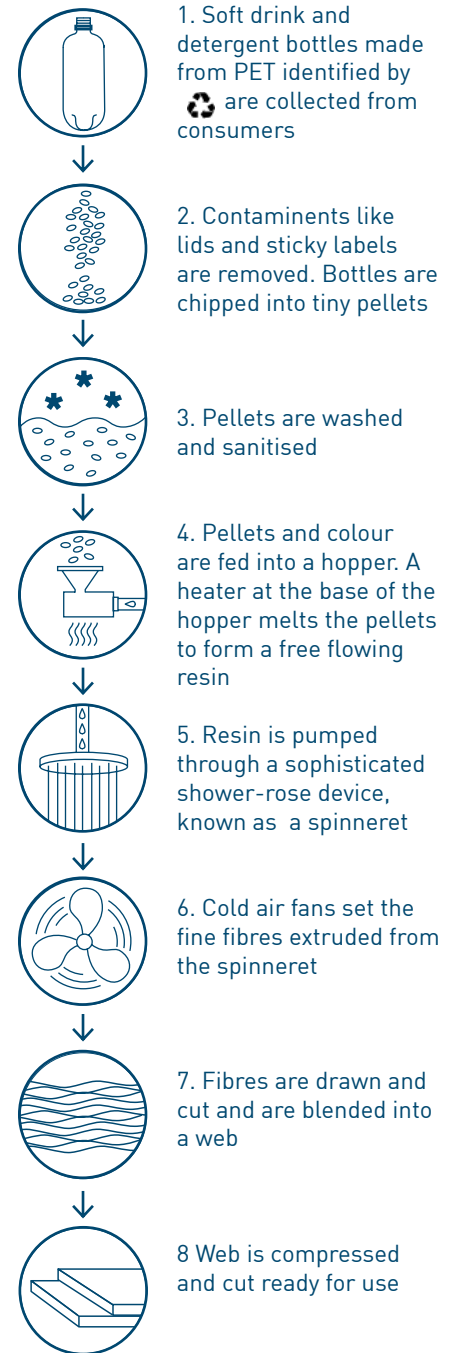

WOVENIMAGE.COM



IMAGE SHOWS 1x PENDENT SPLAY IN #101 & 1x PENDENT SPLAY IN #325



# PALING



PRODUCT NAME	<b>PALING</b>
COLOURS	6 AVAILABLE SEE ECHOPANEL® 24MM COLOUR PALETTE (PAGE 17-18)
DESIGNER	WOVEN IMAGE, JOINERS BY BANG DESIGN FOR WOVEN IMAGE
ORIGIN	AUSTRALIA
COMPONENTS	CONFIGURATION TO BE SPECIFIED IN ORDER - PANEL OPTIONS INCLUDE: PALING A (END PANEL) & PALING B (MIDDLE PANEL)
JOINERS	JOINER TYPES & FINISHES TO BE SPECIFIED IN ORDER. AVAILABLE IN CREAM #908, CHARCOAL #542 OR COPPER #153
COMPOSITION	PALING PANELS ARE MADE FROM 24MM ECHOPANEL® - ECHOPANEL® IS MADE FROM 100% PET (60% RECYCLED) JOINERS ARE MADE FROM ABS PLASTIC
PANEL DIMENSIONS	PALING A - 285MM x 1750MM PALING B - 285MM x 1750MM
PANEL THICKNESS	24MM
WEIGHT	3000G/M <sup>2</sup> (+/- 10%)

## COMPONENTS

### PANELS:

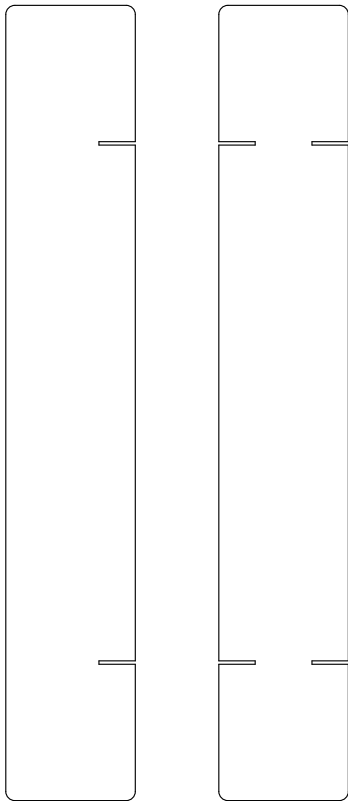

END PANEL  
**PALING A**

MIDDLE PANEL  
**PALING B**

### JOINERS:



JOINER **STRAIGHT**  
195 x 25 x 28MM



JOINER **90**  
128.2 x 128.2 x 25 x 28MM



JOINER **120**  
198 x 25 x 28MM



JOINER **T**  
195 x 128 x 25 x 28MM



JOINER **X**  
228 x 228 x 25 x 28MM



JOINER **Y**  
198 x 198 x 25 x 28MM

ALL JOINERS COME IN PACKS OF 2.  
AVAILABLE FINISHES: #908 CREAM, #542 CHARCOAL AND/OR #153 COPPER.

# PLATOON



PRODUCT NAME	<b>PLATOON</b>
COLOURS	6 AVAILABLE SEE ECHOPANEL® 24MM COLOUR PALETTE (PAGE 17-18)
DESIGNER	WOVEN IMAGE, JOINERS BY BANG DESIGN FOR WOVEN IMAGE
ORIGIN	AUSTRALIA
COMPONENTS	KIT INCLUDES: 2x PLATOON END PANELS 4x PLATOON MIDDLE PANELS 10x PIVOT JOINERS
JOINERS	JOINER FINISH TO BE SPECIFIED IN ORDER. AVAILABLE IN CREAM #908 OR CHARCOAL #542
COMPOSITION	PLATOON PANELS ARE MADE FROM 24MM ECHOPANEL® - ECHOPANEL® IS MADE FROM 100% PET (60% RECYCLED) PIVOT JOINERS ARE MADE FROM ABS PLASTIC
FULL DIMENSIONS	1750MM x 3500MM (CONFIGURATION INCLUDES 4x MIDDLE PANELS & 2x END PANELS)
PANEL THICKNESS	24MM
WEIGHT	13.8KG PER KIT

## COMPONENTS

### PANELS:

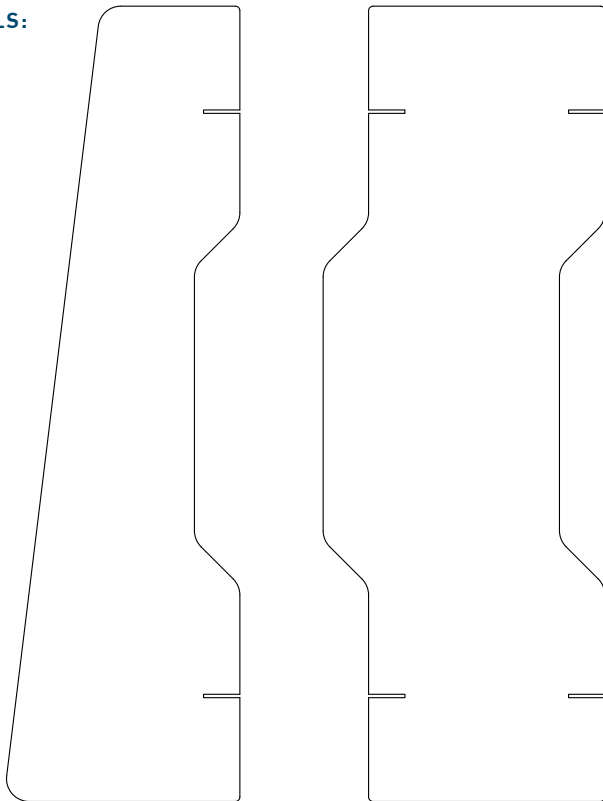

END PANEL  
**PLATOON**

MIDDLE PANEL  
**PLATOON**

### JOINER:

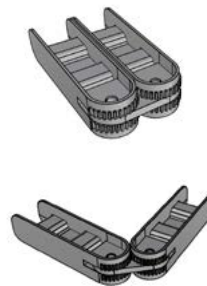

JOINER **PIVOT**  
195 x 25 x 28MM

ALL PLATOON KITS INCLUDES 10x PIVOT JOINERS  
AVAILABLE FINISHES: #908 CREAM OR #542 CHARCOAL.



# WRAP

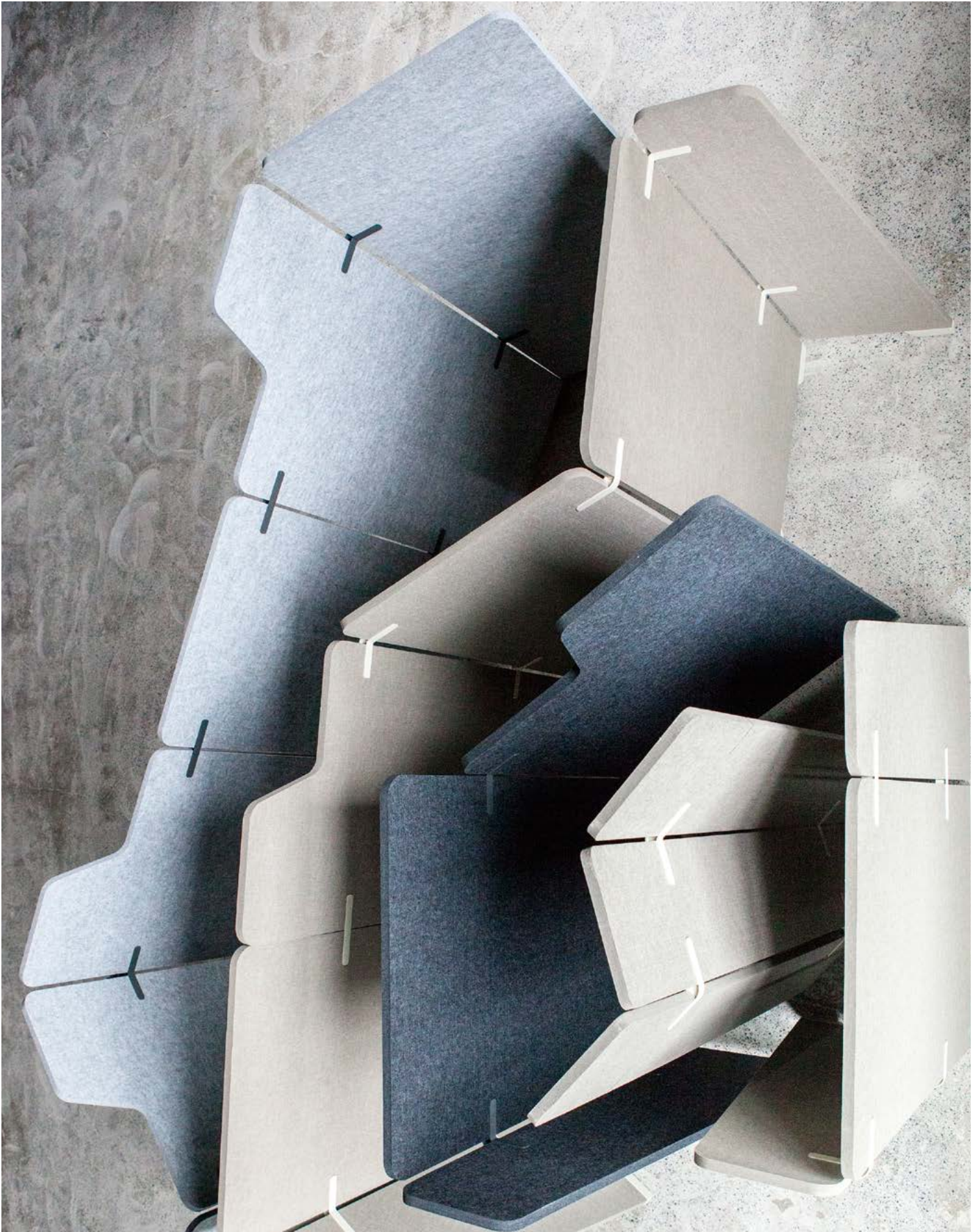



PRODUCT NAME	<b>WRAP</b>
COLOURS	6 AVAILABLE SEE ECHOPANEL® 24MM COLOUR PALETTE (PAGE 17-18)
DESIGNER	BANG DESIGN FOR WOVEN IMAGE
ORIGIN	AUSTRALIA
COMPONENTS	CONFIGURATION TO BE SPECIFIED IN ORDER - PANEL OPTIONS INCLUDE: WRAP A (END TALL) WRAP B (END SHORT) WRAP C (FLAT TALL) OR WRAP C2 (FLAT TALL END) WRAP D (FLAT SHORT) OR WRAP D2 (FLAT SHORT END) WRAP E (STEP UP)
JOINERS & FEET	FEET PLUS JOINER TYPES & FINISHES TO BE SPECIFIED IN ORDER. AVAILABLE IN CREAM #908, CHARCOAL #542 OR COPPER #153
COMPOSITION	WRAP PANELS ARE MADE FROM 24MM ECHOPANEL® - ECHOPANEL® IS MADE FROM 100% PET (60% RECYCLED) JOINERS ARE MADE FROM ABS PLASTIC
PANEL DIMENSIONS	SEE ABOVE
PANEL THICKNESS	24MM
WEIGHT	3000G/M <sup>2</sup> (+/- 10%)

## COMPONENTS

### PANELS:

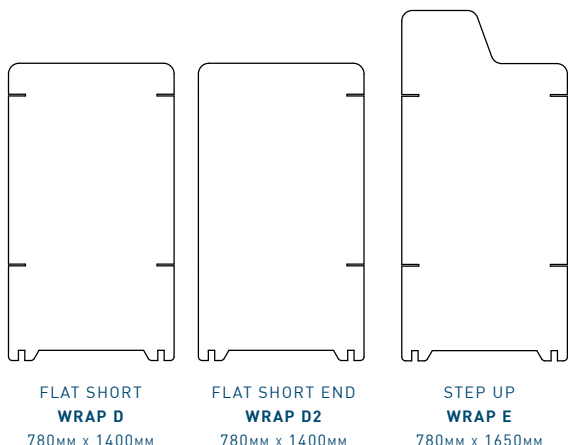
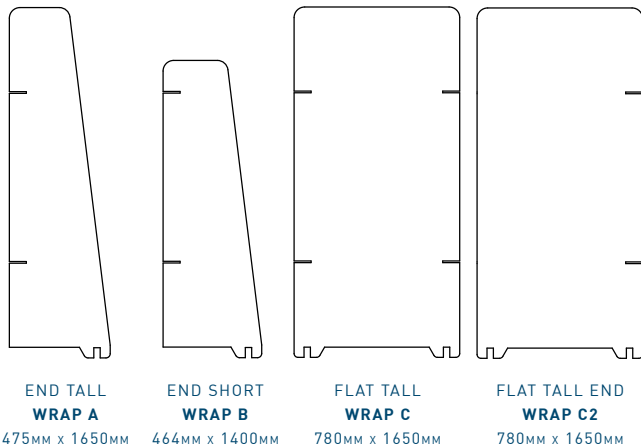

### JOINERS:



**JOINER STRAIGHT**  
195 x 25 x 28MM



**JOINER 90**  
128.2 x 128.2 x 25 x 28MM



**JOINER 120**  
198 x 25 x 28MM



**JOINER T**  
195 x 128 x 25 x 28MM



**JOINER X**  
228 x 228 x 25 x 28MM



**JOINER Y**  
198 x 198 x 25 x 28MM

### FEET:



**FOOT/ADJUSTER**  
147 x 49 x 25 x 28MM

ALL JOINERS COME IN PACKS OF 2. FOOT COMES 1 PER PACK.  
AVAILABLE FINISHES: #908 CREAM, #542 CHARCOAL AND/OR #153 COPPER.

## SUSPENDED SPACE DIVIDERS

---

# P E N D E N T

Introducing the latest in innovative and smart interior solutions from Woven Image®. The Pendent Collection is a new range of ceiling-suspended room or space dividers that comes in a unique selection of cut-out designs and/or solid panels in 12mm and 24mm EchoPanel®.

Each Pendent comes with a Component Kit which includes a beautifully resolved hanging system created by Bang Design® for Woven Image®. Pendent packs can be configured to include a variety of Pendent designs in all available EchoPanel® colours.

SEE PAGE 17-18 FOR ECHOPANEL® 12MM AND 24MM COLOUR PALETTE.

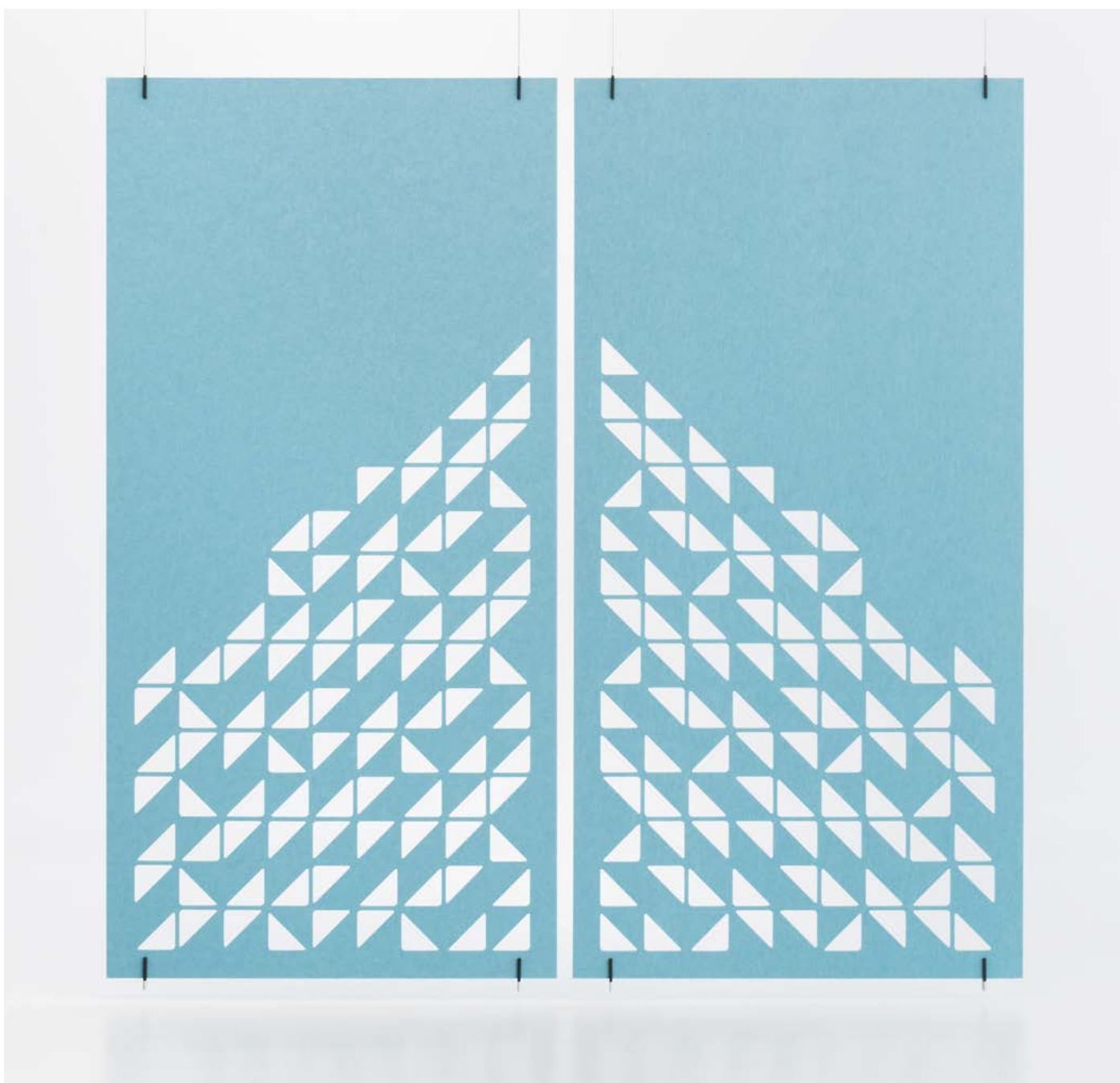



2x PENDENT 24MM IN #442 - SHOWING BOTTOM BRACKET CLIPS WITH SPACER



# SUSPENDED SPACE DIVIDERS

## PENDENT TANDEM



1x PENDENT TANDEM IN COLOURWAY #551

PRODUCT NAME	<b>PENDENT TANDEM</b>
COLOURS	20 AVAILABLE SEE ECHOPANEL® 12MM COLOUR PALETTE (PAGE 17-18)
DESIGNER	WOVEN IMAGE & BANG DESIGN
ORIGIN	AUSTRALIA
COMPONENTS	KIT INCLUDES: 1x CUT ECHOPANEL® 12MM (100% PET - 60% RECYCLED) 1x PENDENT HANGING COMPONENT KIT 12MM
PANEL DIMENSIONS	2400MM X 1200MM
PANEL THICKNESS	12MM
WEIGHT	6.4KG PER KIT

PLEASE REFER TO PRODUCT SPECIFICATION SHEET FOR PERFORMANCE REPORTS AND FURTHER INFORMATION OR VISIT [WOVENIMAGE.COM](http://WOVENIMAGE.COM)

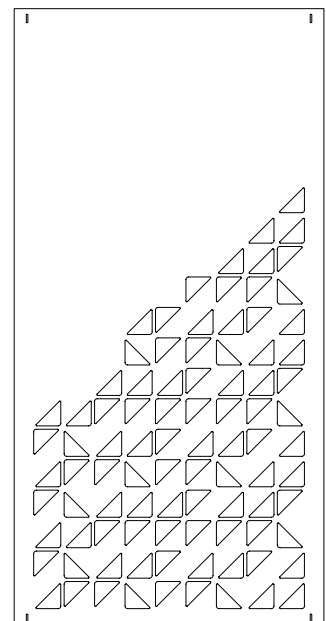

# PENDENT SUMMIT



2x PENDENT SUMMITS IN #365 & 1x PENDENT SUMMIT IN #442

PRODUCT NAME	<b>PENDENT SUMMIT</b>
COLOURS	20 AVAILABLE SEE ECHOPANEL® 12MM COLOUR PALETTE (PAGE 17-18)
DESIGNER	WOVEN IMAGE & BANG DESIGN
ORIGIN	AUSTRALIA
COMPONENTS	KIT INCLUDES: 1x CUT ECHOPANEL® 12MM (100% PET - 60% RECYCLED) 1x PENDENT HANGING COMPONENT KIT 12MM
PANEL DIMENSIONS	2400MM x 1200MM
PANEL THICKNESS	12MM
WEIGHT	6.4KG PER KIT

PLEASE REFER TO PRODUCT SPECIFICATION SHEET FOR PERFORMANCE REPORTS AND FURTHER INFORMATION OR VISIT [WOVENIMAGE.COM](http://WOVENIMAGE.COM)

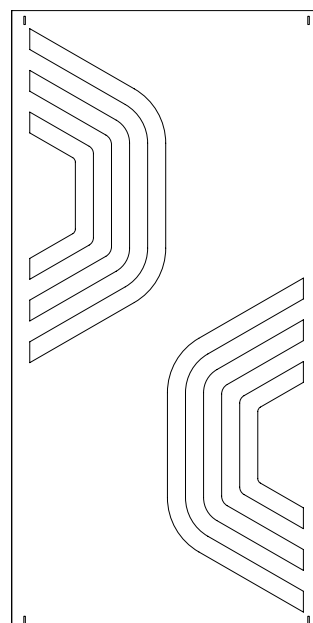

# SUSPENDED SPACE DIVIDERS

## PENDENT SPLAY



1x PENDENT SPLAYED IN #365, 1x PENDENT SPLAY IN #325 & 1x PENDENT SPLAY IN #101

PRODUCT NAME	<b>PENDENT SPLAY</b>
COLOURS	20 AVAILABLE SEE ECHOPANEL® 12MM COLOUR PALETTE (PAGE 17-18)
DESIGNER	WOVEN IMAGE & BANG DESIGN
ORIGIN	AUSTRALIA
COMPONENTS	KIT INCLUDES: 1x CUT ECHOPANEL® 12MM (100% PET - 60% RECYCLED) 1x PENDENT HANGING COMPONENT KIT 12MM
PANEL DIMENSIONS	2400MM x 1200MM
PANEL THICKNESS	12MM
WEIGHT	6.4KG PER KIT

PLEASE REFER TO PRODUCT SPECIFICATION SHEET FOR PERFORMANCE REPORTS AND FURTHER INFORMATION OR VISIT [WOVENIMAGE.COM](http://WOVENIMAGE.COM)

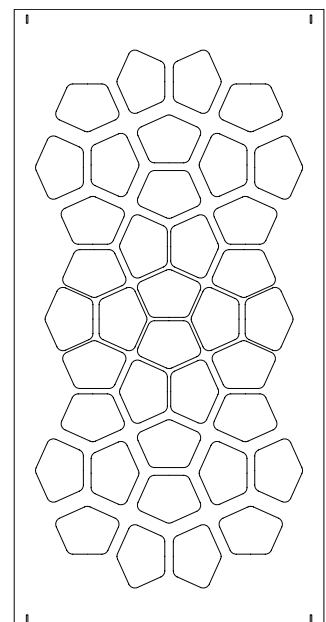



# P E N D E N T   D O T



1x PENDENT DOT IN #101 [ALSO SHOWING PENDENT 12MM IN #381 & #442]

PRODUCT NAME	<b>P E N D E N T   D O T</b>
COLOURS	20 AVAILABLE SEE ECHOPANEL® 12MM COLOUR PALETTE (PAGE 17-18)
DESIGNER	WOVEN IMAGE & BANG DESIGN
ORIGIN	AUSTRALIA
COMPONENTS	KIT INCLUDES: 1x CUT ECHOPANEL® 12MM (100% PET - 60% RECYCLED) 1x PENDENT HANGING COMPONENT KIT 12MM
PANEL DIMENSIONS	2400MM X 1200MM
PANEL THICKNESS	12MM
WEIGHT	6.4KG PER KIT

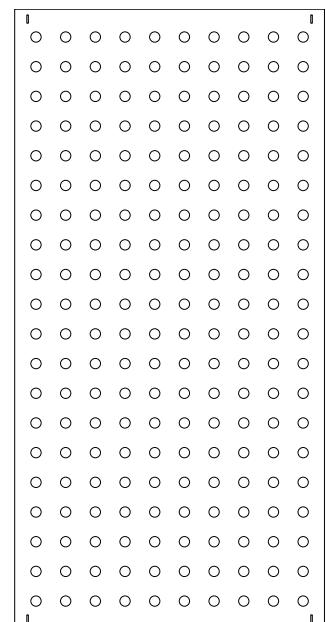

PLEASE REFER TO PRODUCT SPECIFICATION SHEET FOR PERFORMANCE REPORTS AND FURTHER INFORMATION OR VISIT [WOVENIMAGE.COM](http://WOVENIMAGE.COM)

# SUSPENDED SPACE DIVIDERS

---

## PENDENT 12MM

PRODUCT NAME	<b>PENDENT 12MM</b>
COLOURS	20 AVAILABLE SEE ECHOPANEL® 12MM COLOUR PALETTE (PAGE 17-18)
DESIGNER	WOVEN IMAGE & BANG DESIGN
ORIGIN	AUSTRALIA
COMPONENTS	KIT INCLUDES: 1x CUT ECHOPANEL® 12MM (100% PET - 60% RECYCLED) 1x PENDENT HANGING COMPONENT KIT 12MM
PANEL DIMENSIONS	2400MM x 1200MM
PANEL THICKNESS	12MM
WEIGHT	6.4KG PER KIT

PLEASE REFER TO PRODUCT SPECIFICATION SHEET FOR PERFORMANCE REPORTS AND FURTHER INFORMATION OR VISIT [WOVENIMAGE.COM](http://WOVENIMAGE.COM)

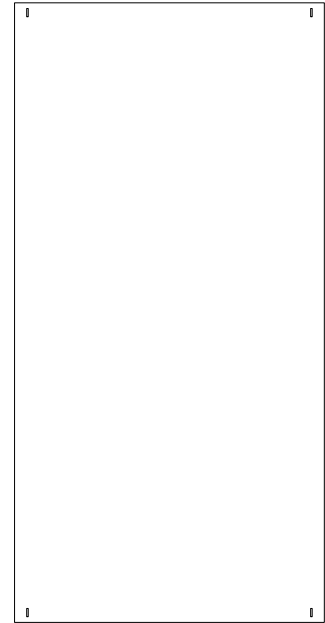

---

## PENDENT 24MM

PRODUCT NAME	<b>PENDENT 24MM</b>
COLOURS	6 AVAILABLE SEE ECHOPANEL® 12MM COLOUR PALETTE (PAGE 17-18)
DESIGNER	WOVEN IMAGE & BANG DESIGN
ORIGIN	AUSTRALIA
COMPONENTS	KIT INCLUDES: 1x CUT ECHOPANEL® 24MM (100% PET - 60% RECYCLED) 1x PENDENT HANGING COMPONENT KIT 24MM
PANEL DIMENSIONS	2400MM x 908MM
PANEL THICKNESS	24MM
WEIGHT	7KG PER KIT

PLEASE REFER TO PRODUCT SPECIFICATION SHEET FOR PERFORMANCE REPORTS AND FURTHER INFORMATION OR VISIT [WOVENIMAGE.COM](http://WOVENIMAGE.COM)

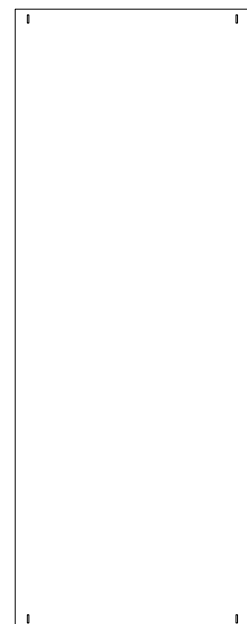

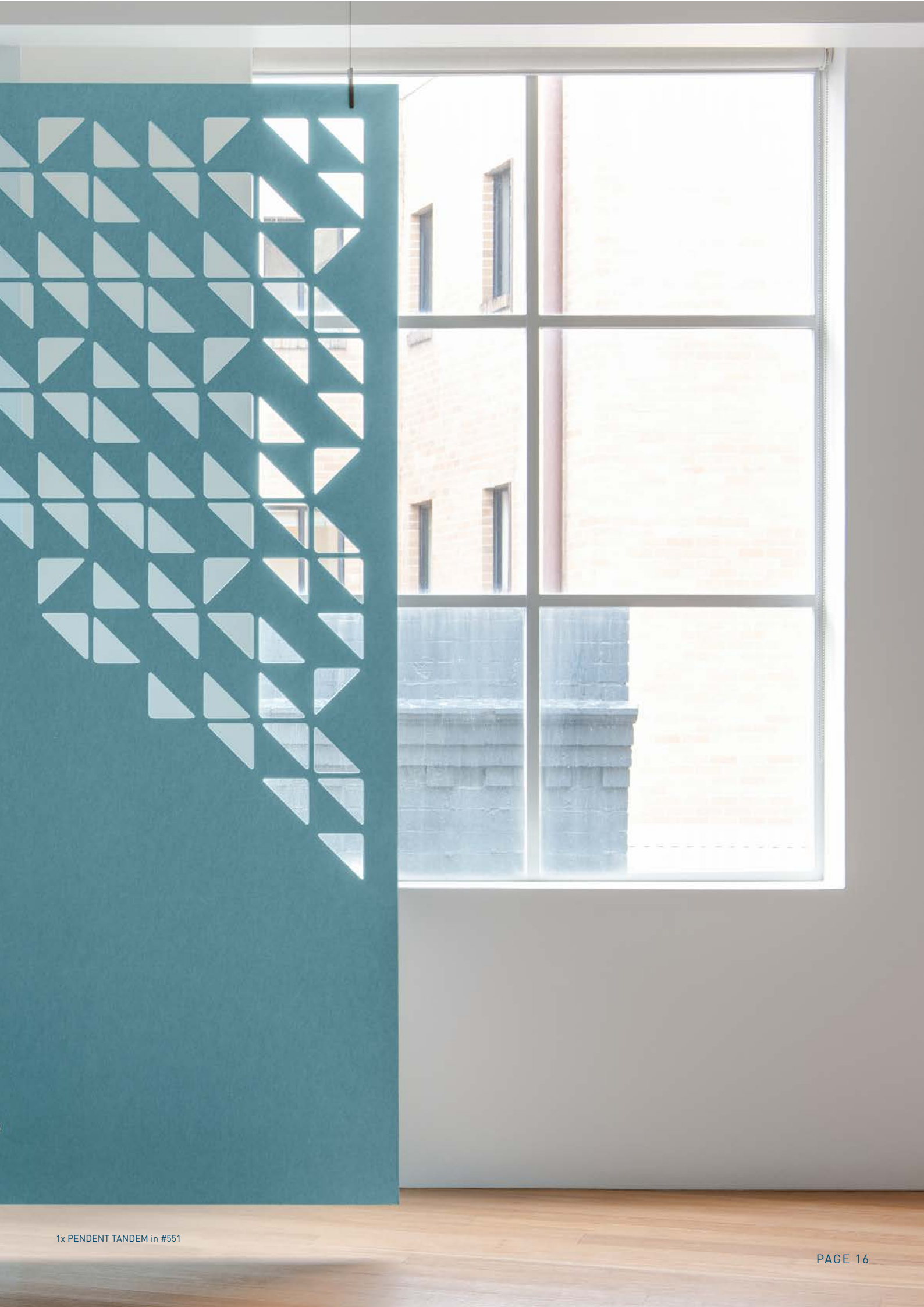



## COLOUR PALETTE

EchoPanel® has the most comprehensive range of colours that are 100% consistent and vibrant through to the core with an unparalleled silky, designer, surface finish. The standard range includes all 20 colours in the prominent 12mm thickness with a selection of these colours also available in the 7mm and 24mm thicknesses.

SEE PAGE 6 FOR ADDITIONAL SPECIFICATIONS & PERFORMANCE DETAILS

LEGEND:

- COLOUR AVAILABLE ECHOPANEL® 7MM
- COLOUR AVAILABLE ECHOPANEL® 12MM  
PRODUCTS INCLUDE: PENDENTS
- COLOUR AVAILABLE ECHOPANEL® 24MM  
PRODUCTS INCLUDE: PALING, PLATOON, WRAP & PENDENTS

## NEUTRALS



542



442



444



101



402



580



908



500



---

Contact your Woven Image Account Manager for more information about the EchoPanel® colour palette or for any sampling.

## VIBRANTS



576



258



295



151



579



362

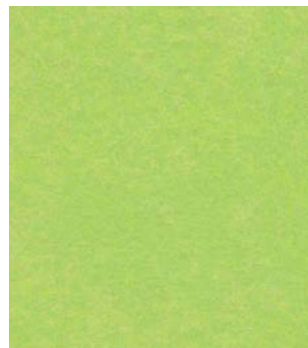

381



108



365



273



551

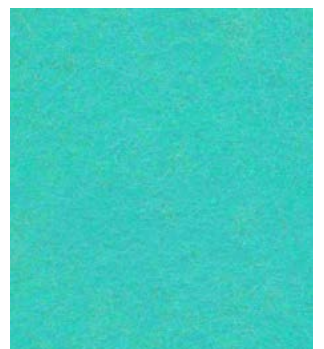

325





