

SPACE DIVIDING SYSTEMS

WOVENIMAGE.COM

wvi
WOVEN IMAGE®



WOVEN IMAGE®

DESIGNED SPACE SOLUTIONS WITH ECHOPANEL®

Space dividers are the semi-permanent features, that assist in creating and organising open-plan spaces - be it the classroom, office or even in a restaurant. Woven Image® has designed a collection of modular dividing systems made from the leading opportune product - EchoPanel® - to achieve the important characteristics for such systems; including sound absorption and by being a lightweight, agile material.

By using EchoPanel®, the interior space maintains a sustainably responsible standard. EchoPanel® is the leading, specialised contract material with top level fire ratings, but at the core of its ethos is also dematerialisation and recycling. EchoPanel® is made from up to 60% post-consumer waste sourced from recycled PET bottles. Impressively, in 2015 alone, Woven Image® saved in excess of 283 tonnes of PET plastic from going to landfills, repurposing this waste for EchoPanel® products. It's no wonder, then, that EchoPanel® can secure maximum credits under GECA's Green Star sustainability rating tool, as administered by the Green Building Council Australia.

A conscious aesthetic is everything and EchoPanel® comes in the largest range of colour options for ceiling-suspended space dividers such as the Pendants (made from EchoPanel® 12MM & 24MM) and free-standing space dividers made from EchoPanel® 24MM. Newly released additions to the EchoPanel® 24MM range mean that there are more options than ever for classic Woven Image® products: Paling, Platoon and Wrap.

Aside from effectively and efficiently organising a space, the products in this brochure can be easily adapted to immediately improve the sound quality in a space where privacy or improved acoustics is desired. Free-standing space dividers can be configured around workstations or break-out areas, granting more privacy. Ceiling-suspended space dividers can be added to a hotel lobby or broad area restaurant space, where intelligently designed division and aesthetic is required.

For more information about the products in this brochure or EchoPanel®, please contact your Woven Image® Account Manager or visit us online.

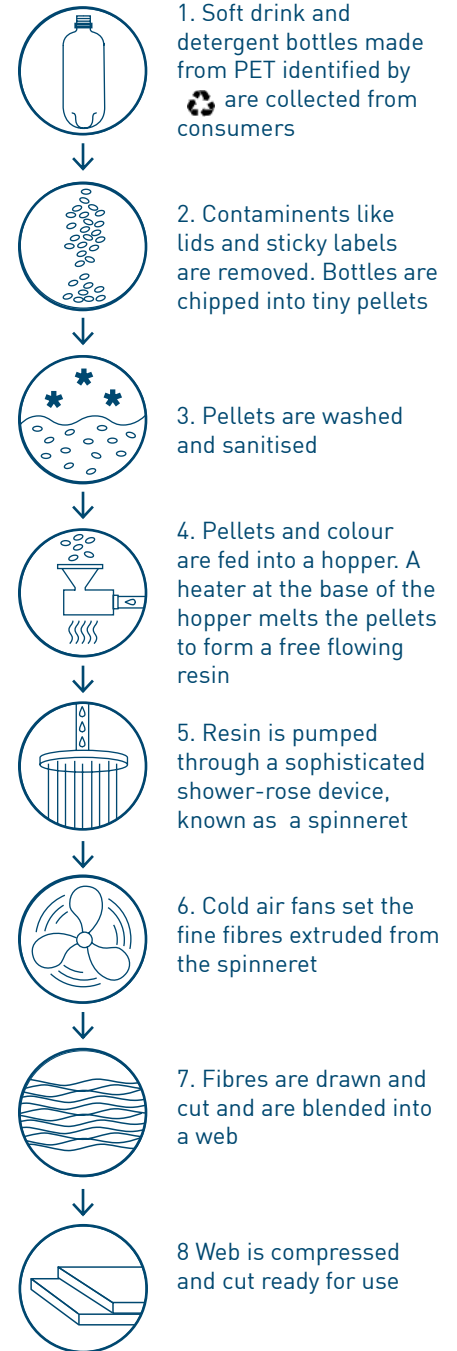

WOVENIMAGE.COM



IMAGE SHOWS 1x PENDENT SPLAY IN #101 & 1x PENDENT SPLAY IN #325

PALING



PRODUCT NAME	PALING
COLOURS	6 AVAILABLE SEE ECHOPANEL® 24MM COLOUR PALETTE (PAGE 17-18)
DESIGNER	WOVEN IMAGE, JOINERS BY BANG DESIGN FOR WOVEN IMAGE
ORIGIN	AUSTRALIA
COMPONENTS	CONFIGURATION TO BE SPECIFIED IN ORDER - PANEL OPTIONS INCLUDE: PALING A (END PANEL) & PALING B (MIDDLE PANEL)
JOINERS	JOINER TYPES & FINISHES TO BE SPECIFIED IN ORDER. AVAILABLE IN CREAM #908, CHARCOAL #542 OR COPPER #153
COMPOSITION	PALING PANELS ARE MADE FROM 24MM ECHOPANEL® - ECHOPANEL® IS MADE FROM 100% PET (60% RECYCLED) JOINERS ARE MADE FROM ABS PLASTIC
PANEL DIMENSIONS	PALING A - 285MM x 1750MM PALING B - 285MM x 1750MM
PANEL THICKNESS	24MM
WEIGHT	3000G/M ² (+/- 10%)

COMPONENTS

PANELS:

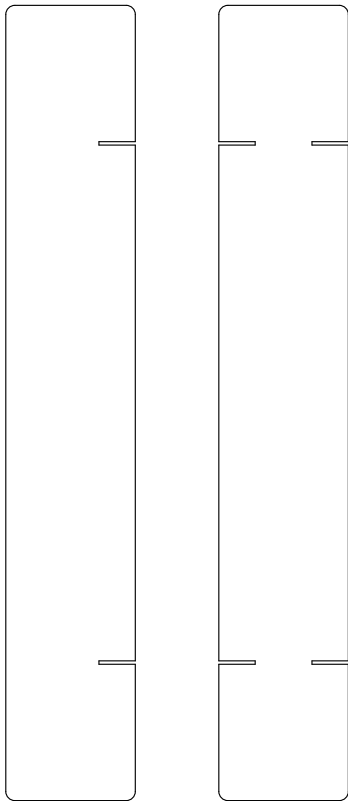

END PANEL
PALING A

MIDDLE PANEL
PALING B

JOINERS:



JOINER **STRAIGHT**
195 x 25 x 28MM



JOINER **90**
128.2 x 128.2 x 25 x 28MM



JOINER **120**
198 x 25 x 28MM



JOINER **T**
195 x 128 x 25 x 28MM



JOINER **X**
228 x 228 x 25 x 28MM



JOINER **Y**
198 x 198 x 25 x 28MM

ALL JOINERS COME IN PACKS OF 2.
AVAILABLE FINISHES: #908 CREAM, #542 CHARCOAL AND/OR #153 COPPER.

PLATOON



PRODUCT NAME	PLATOON
COLOURS	6 AVAILABLE SEE ECHOPANEL® 24MM COLOUR PALETTE (PAGE 17-18)
DESIGNER	WOVEN IMAGE, JOINERS BY BANG DESIGN FOR WOVEN IMAGE
ORIGIN	AUSTRALIA
COMPONENTS	KIT INCLUDES: 2x PLATOON END PANELS 4x PLATOON MIDDLE PANELS 10x PIVOT JOINERS
JOINERS	JOINER FINISH TO BE SPECIFIED IN ORDER. AVAILABLE IN CREAM #908 OR CHARCOAL #542
COMPOSITION	PLATOON PANELS ARE MADE FROM 24MM ECHOPANEL® - ECHOPANEL® IS MADE FROM 100% PET (60% RECYCLED) PIVOT JOINERS ARE MADE FROM ABS PLASTIC
FULL DIMENSIONS	1750MM x 3500MM (CONFIGURATION INCLUDES 4x MIDDLE PANELS & 2x END PANELS)
PANEL THICKNESS	24MM
WEIGHT	13.8KG PER KIT

COMPONENTS

PANELS:

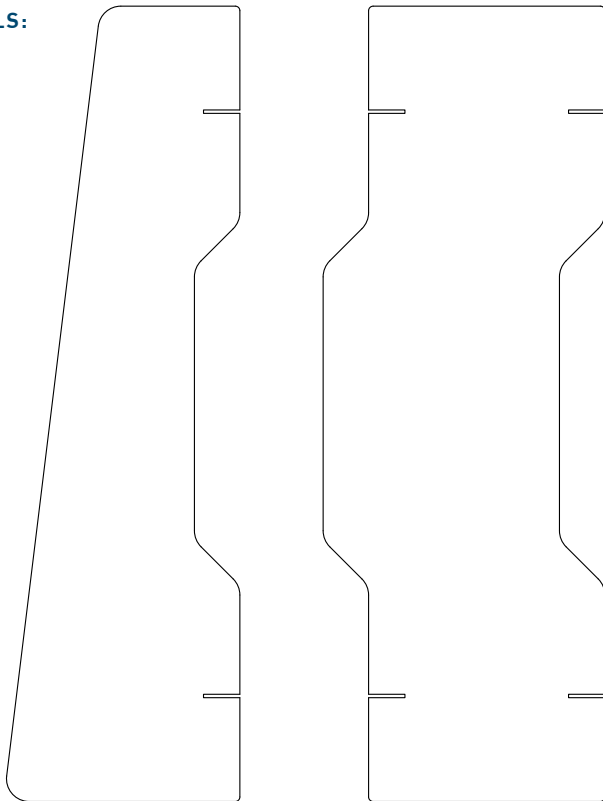

END PANEL
PLATOON

MIDDLE PANEL
PLATOON

JOINER:

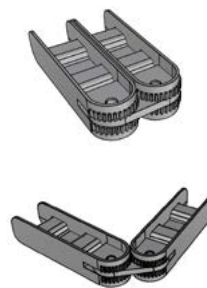

JOINER **PIVOT**
195 x 25 x 28MM

ALL PLATOON KITS INCLUDES 10x PIVOT JOINERS
AVAILABLE FINISHES: #908 CREAM OR #542 CHARCOAL.

WRAP

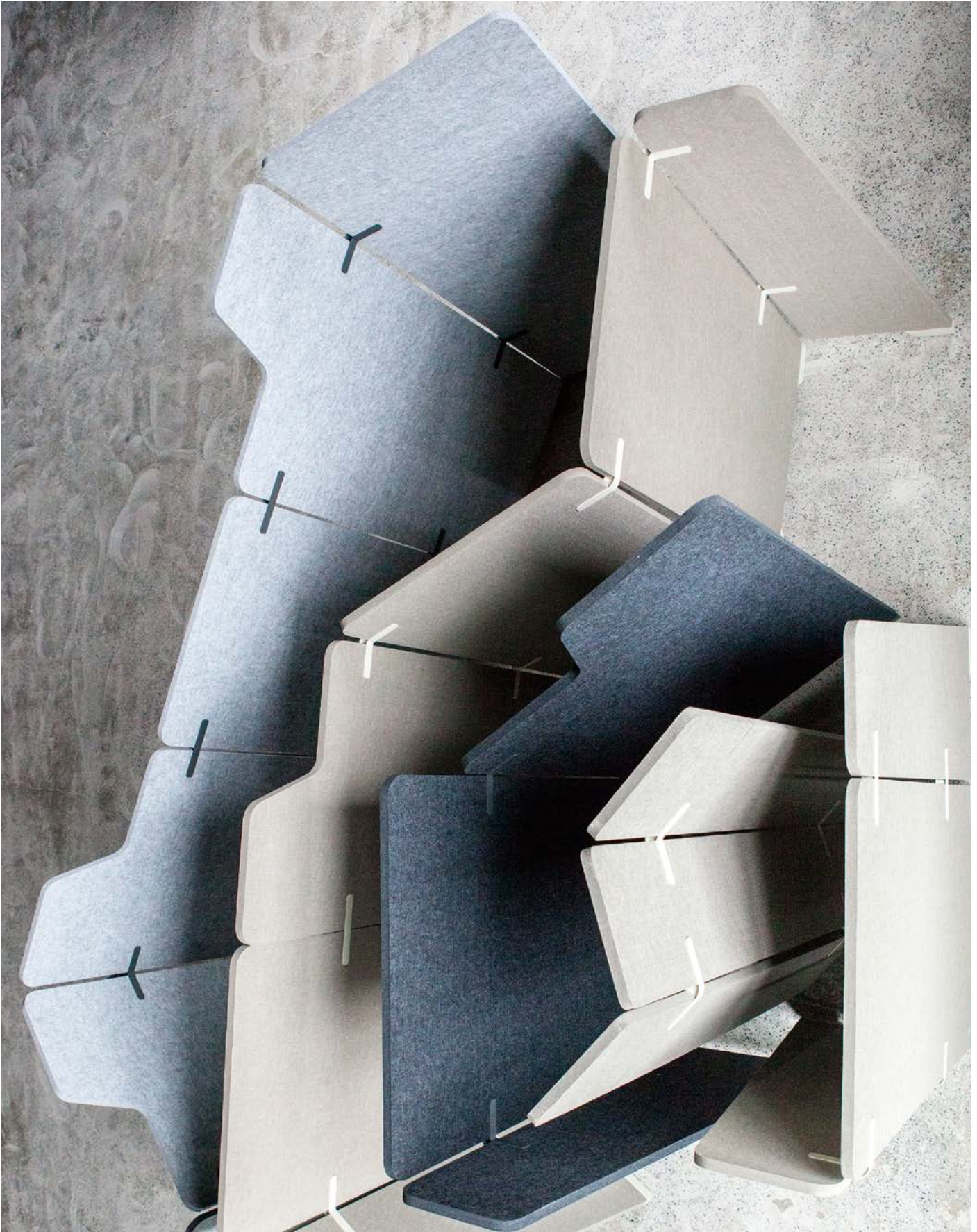

PRODUCT NAME	WRAP
COLOURS	6 AVAILABLE SEE ECHOPANEL® 24MM COLOUR PALETTE (PAGE 17-18)
DESIGNER	BANG DESIGN FOR WOVEN IMAGE
ORIGIN	AUSTRALIA
COMPONENTS	CONFIGURATION TO BE SPECIFIED IN ORDER - PANEL OPTIONS INCLUDE: WRAP A (END TALL) WRAP B (END SHORT) WRAP C (FLAT TALL) OR WRAP C2 (FLAT TALL END) WRAP D (FLAT SHORT) OR WRAP D2 (FLAT SHORT END) WRAP E (STEP UP)
JOINERS & FEET	FEET PLUS JOINER TYPES & FINISHES TO BE SPECIFIED IN ORDER. AVAILABLE IN CREAM #908, CHARCOAL #542 OR COPPER #153
COMPOSITION	WRAP PANELS ARE MADE FROM 24MM ECHOPANEL® - ECHOPANEL® IS MADE FROM 100% PET (60% RECYCLED) JOINERS ARE MADE FROM ABS PLASTIC
PANEL DIMENSIONS	SEE ABOVE
PANEL THICKNESS	24MM
WEIGHT	3000G/M ² (+/- 10%)

COMPONENTS

PANELS:

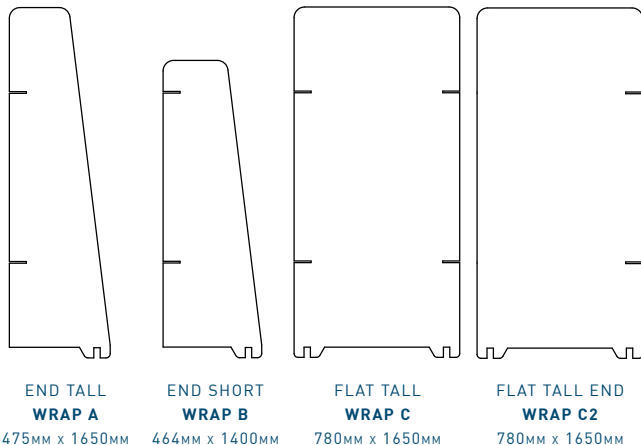

END TALL WRAP A 475MM x 1650MM
END SHORT WRAP B 464MM x 1400MM
FLAT TALL WRAP C 780MM x 1650MM
FLAT TALL END WRAP C2 780MM x 1650MM

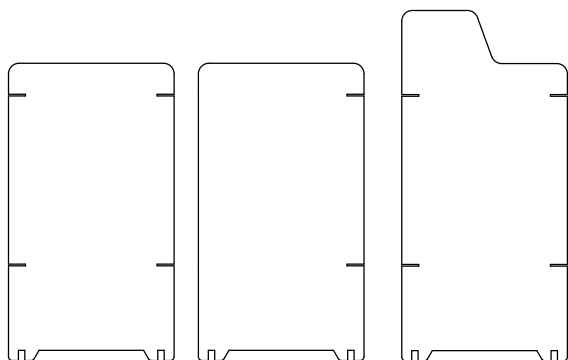

FLAT SHORT WRAP D 780MM x 1400MM
FLAT SHORT END WRAP D2 780MM x 1400MM
STEP UP WRAP E 780MM x 1650MM

JOINERS:



JOINER STRAIGHT
195 x 25 x 28MM



JOINER 90
128.2 x 128.2 x 25 x 28MM



JOINER 120
198 x 25 x 28MM



JOINER T
195 x 128 x 25 x 28MM



JOINER X
228 x 228 x 25 x 28MM



JOINER Y
198 x 198 x 25 x 28MM

FEET:



FOOT/ADJUSTER
147 x 49 x 25 x 28MM

ALL JOINERS COME IN PACKS OF 2. FOOT COMES 1 PER PACK.
AVAILABLE FINISHES: #908 CREAM, #542 CHARCOAL AND/OR #153 COPPER.

SUSPENDED SPACE DIVIDERS

PENDENT

Introducing the latest in innovative and smart interior solutions from Woven Image®. The Pendent Collection is a new range of ceiling-suspended room or space dividers that comes in a unique selection of cut-out designs and/or solid panels in 12mm and 24mm EchoPanel®.

Each Pendent comes with a Component Kit which includes a beautifully resolved hanging system created by Bang Design® for Woven Image®. Pendent packs can be configured to include a variety of Pendent designs in all available EchoPanel® colours.

SEE PAGE 17-18 FOR ECHOPANEL® 12MM AND 24MM COLOUR PALETTE.

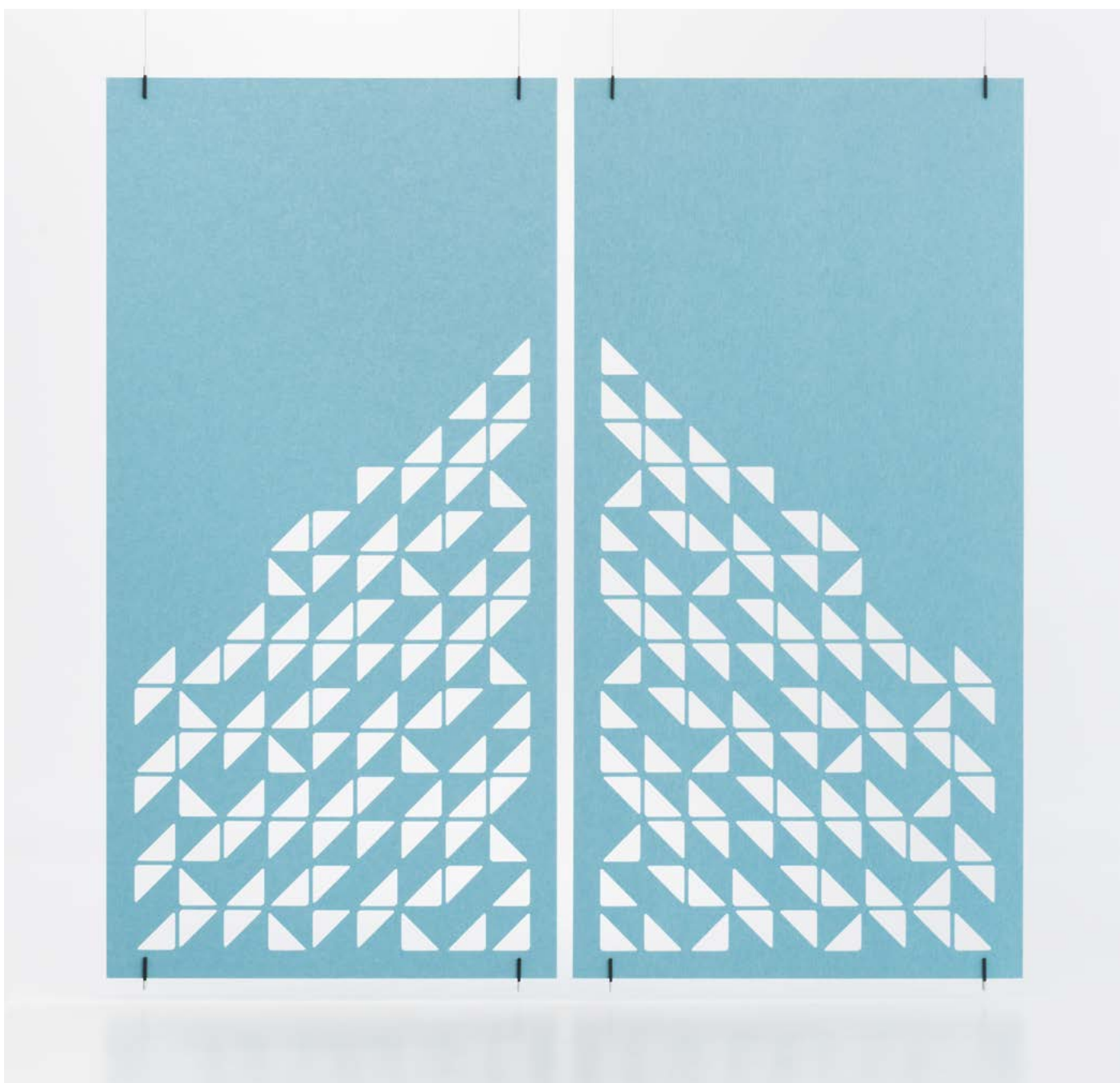



2x PENDENT 24MM IN #442 - SHOWING BOTTOM BRACKET CLIPS WITH SPACER

SUSPENDED SPACE DIVIDERS

PENDENT TANDEM



1x PENDENT TANDEM IN COLOURWAY #551

PRODUCT NAME	PENDENT TANDEM
COLOURS	20 AVAILABLE SEE ECHOPANEL® 12MM COLOUR PALETTE (PAGE 17-18)
DESIGNER	WOVEN IMAGE & BANG DESIGN
ORIGIN	AUSTRALIA
COMPONENTS	KIT INCLUDES: 1x CUT ECHOPANEL® 12MM (100% PET - 60% RECYCLED) 1x PENDENT HANGING COMPONENT KIT 12MM
PANEL DIMENSIONS	2400MM x 1200MM
PANEL THICKNESS	12MM
WEIGHT	6.4KG PER KIT

PLEASE REFER TO PRODUCT SPECIFICATION SHEET FOR PERFORMANCE REPORTS AND FURTHER INFORMATION OR VISIT WOVENIMAGE.COM

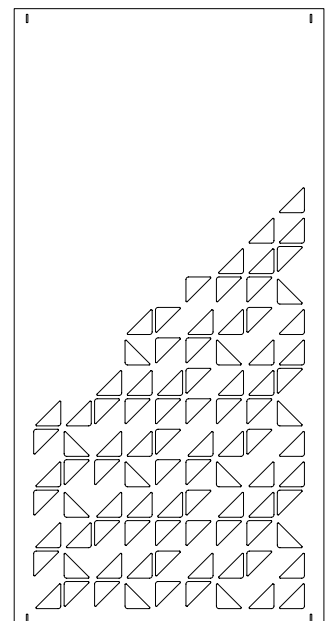

PENDENT SUMMIT



2x PENDENT SUMMITS IN #365 & 1x PENDENT SUMMIT IN #442

PRODUCT NAME	PENDENT SUMMIT
COLOURS	20 AVAILABLE SEE ECHOPANEL® 12MM COLOUR PALETTE (PAGE 17-18)
DESIGNER	WOVEN IMAGE & BANG DESIGN
ORIGIN	AUSTRALIA
COMPONENTS	KIT INCLUDES: 1x CUT ECHOPANEL® 12MM (100% PET - 60% RECYCLED) 1x PENDENT HANGING COMPONENT KIT 12MM
PANEL DIMENSIONS	2400MM x 1200MM
PANEL THICKNESS	12MM
WEIGHT	6.4KG PER KIT

PLEASE REFER TO PRODUCT SPECIFICATION SHEET FOR PERFORMANCE REPORTS AND FURTHER INFORMATION OR VISIT WOVENIMAGE.COM

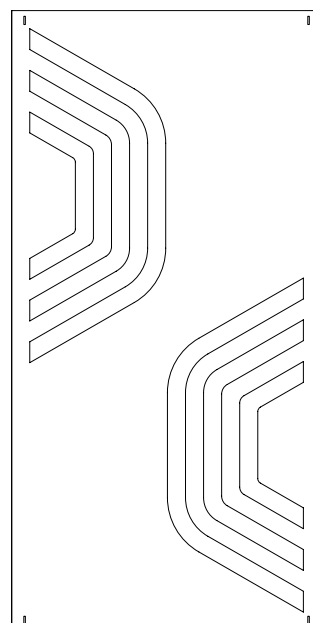

SUSPENDED SPACE DIVIDERS

PENDENT SPLAY



1x PENDENT SPLAYED IN #365, 1x PENDENT SPLAY IN #325 & 1x PENDENT SPLAY IN #101

PRODUCT NAME	PENDENT SPLAY
COLOURS	20 AVAILABLE SEE ECHOPANEL® 12MM COLOUR PALETTE (PAGE 17-18)
DESIGNER	WOVEN IMAGE & BANG DESIGN
ORIGIN	AUSTRALIA
COMPONENTS	KIT INCLUDES: 1x CUT ECHOPANEL® 12MM (100% PET - 60% RECYCLED) 1x PENDENT HANGING COMPONENT KIT 12MM
PANEL DIMENSIONS	2400MM x 1200MM
PANEL THICKNESS	12MM
WEIGHT	6.4KG PER KIT

PLEASE REFER TO PRODUCT SPECIFICATION SHEET FOR PERFORMANCE REPORTS AND FURTHER INFORMATION OR VISIT WOVENIMAGE.COM

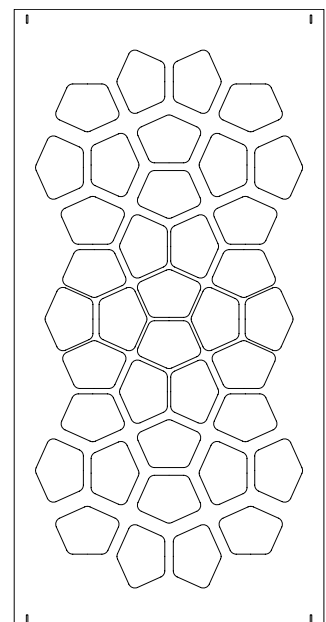

P E N D E N T D O T



1x PENDENT DOT IN #101 [ALSO SHOWING PENDENT 12MM IN #381 & #442]

PRODUCT NAME	P E N D E N T D O T
COLOURS	20 AVAILABLE SEE ECHOPANEL® 12MM COLOUR PALETTE (PAGE 17-18)
DESIGNER	WOVEN IMAGE & BANG DESIGN
ORIGIN	AUSTRALIA
COMPONENTS	KIT INCLUDES: 1x CUT ECHOPANEL® 12MM (100% PET - 60% RECYCLED) 1x PENDENT HANGING COMPONENT KIT 12MM
PANEL DIMENSIONS	2400MM X 1200MM
PANEL THICKNESS	12MM
WEIGHT	6.4KG PER KIT

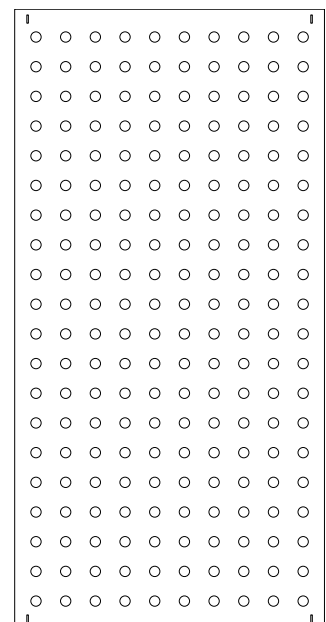

PLEASE REFER TO PRODUCT SPECIFICATION SHEET FOR PERFORMANCE REPORTS AND FURTHER INFORMATION OR VISIT WOVENIMAGE.COM

SUSPENDED SPACE DIVIDERS

PENDENT 12MM

PRODUCT NAME	PENDENT 12MM
COLOURS	20 AVAILABLE SEE ECHOPANEL® 12MM COLOUR PALETTE (PAGE 17-18)
DESIGNER	WOVEN IMAGE & BANG DESIGN
ORIGIN	AUSTRALIA
COMPONENTS	KIT INCLUDES: 1x CUT ECHOPANEL® 12MM (100% PET - 60% RECYCLED) 1x PENDENT HANGING COMPONENT KIT 12MM
PANEL DIMENSIONS	2400MM x 1200MM
PANEL THICKNESS	12MM
WEIGHT	6.4KG PER KIT

PLEASE REFER TO PRODUCT SPECIFICATION SHEET FOR PERFORMANCE REPORTS AND FURTHER INFORMATION OR VISIT WOVENIMAGE.COM

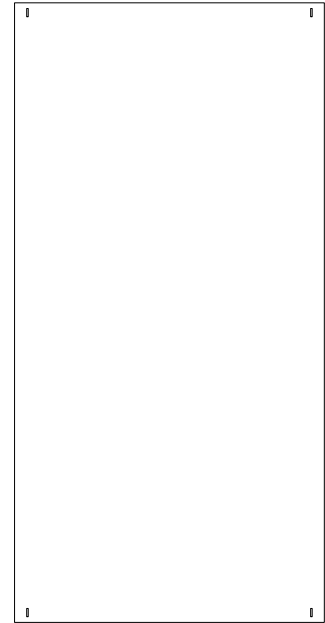

PENDENT 24MM

PRODUCT NAME	PENDENT 24MM
COLOURS	6 AVAILABLE SEE ECHOPANEL® 12MM COLOUR PALETTE (PAGE 17-18)
DESIGNER	WOVEN IMAGE & BANG DESIGN
ORIGIN	AUSTRALIA
COMPONENTS	KIT INCLUDES: 1x CUT ECHOPANEL® 24MM (100% PET - 60% RECYCLED) 1x PENDENT HANGING COMPONENT KIT 24MM
PANEL DIMENSIONS	2400MM x 908MM
PANEL THICKNESS	24MM
WEIGHT	7KG PER KIT

PLEASE REFER TO PRODUCT SPECIFICATION SHEET FOR PERFORMANCE REPORTS AND FURTHER INFORMATION OR VISIT WOVENIMAGE.COM

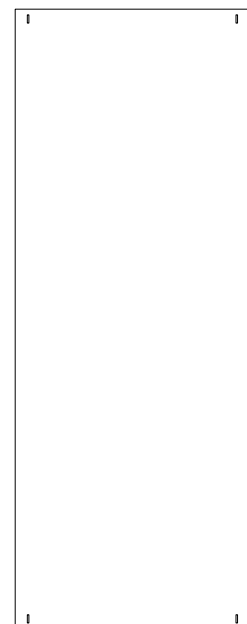

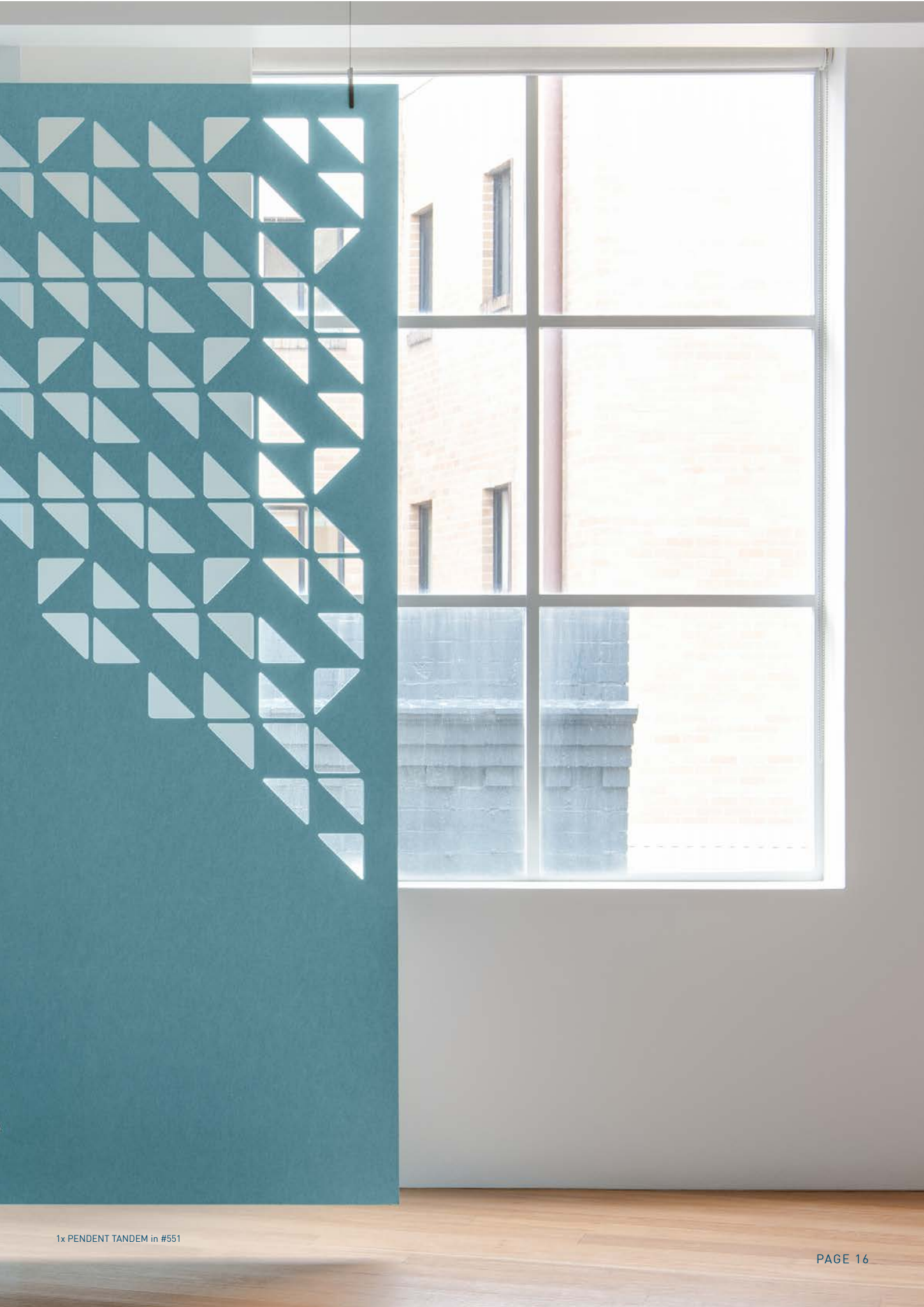

COLOUR PALETTE

EchoPanel® has the most comprehensive range of colours that are 100% consistent and vibrant through to the core with an unparalleled silky, designer, surface finish. The standard range includes all 20 colours in the prominent 12mm thickness with a selection of these colours also available in the 7mm and 24mm thicknesses.

SEE PAGE 6 FOR ADDITIONAL SPECIFICATIONS & PERFORMANCE DETAILS

LEGEND:

- COLOUR AVAILABLE ECHOPANEL® 7MM
- COLOUR AVAILABLE ECHOPANEL® 12MM
PRODUCTS INCLUDE: PENDENTS
- COLOUR AVAILABLE ECHOPANEL® 24MM
PRODUCTS INCLUDE: PALING, PLATOON, WRAP & PENDENTS

NEUTRALS



542



442



444



101



402



580



908



500



Contact your Woven Image Account Manager for more information about the EchoPanel® colour palette or for any sampling.

VIBRANTS



576



258



295



151



579



362

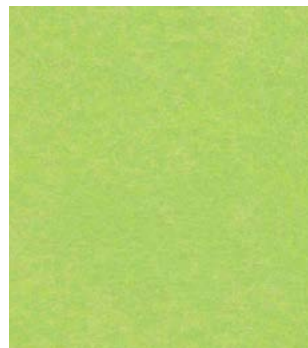

381



108



365



273



551

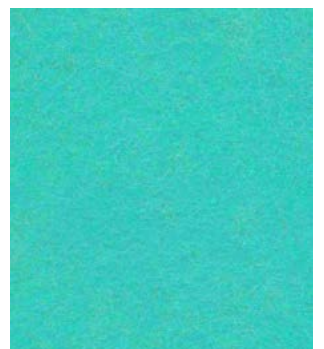

325



