



Fracture Panel

FilaSorb™ 12

acoufelt
making quiet

Product Detail

Product	Fracture Panel
Surface	Wall
Composition	100% Polyester
Material	FilaSorb™
Recycled Content	60% min.
Dimensions	1220 x 2800mm
	Custom size available upon request
Thickness	12mm +/- 10%

Technical Data

Fire Test Method Number	ISO 9705: 1993 Group 1 AS ISO 9705:2003 Group 1 ASTM E84-17a Class A
Indoor Air Quality	SCS-EC10.3-2014 v4.0 meeting standard CDPH/EHLB Standard Method v.1.2-2017, ≤ 0.5mg/m3
Light Fastness	ISO 105-B02 1994, 6-7

Acoustic Performance

Sound Absorption ISO 354-2006
 NRC 0.45 (no air gap)
 NRC 0.54 (12mm air gap)
 NRC 0.64 (20mm air gap)

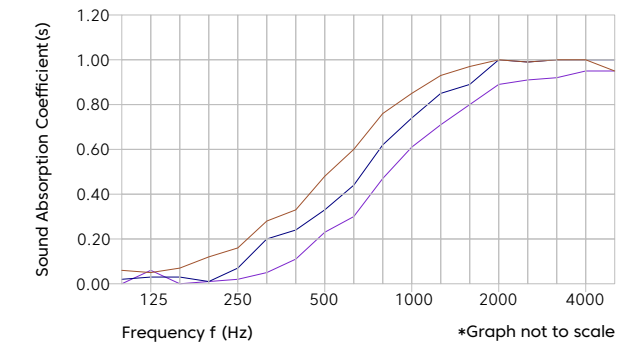

Frequency f (Hz)	125	250	500	1000	2000	4000	NRC
a_s No Air Gap	0.06	0.02	0.23	0.61	0.89	0.95	0.45
12mm a_s Air Gap	0.03	0.14	0.33	0.74	1.00	1.00	0.54
20mm a_s Air Gap	0.05	0.16	0.48	0.85	1.00	1.00	0.64

Product Drawing

Elevation Perspective

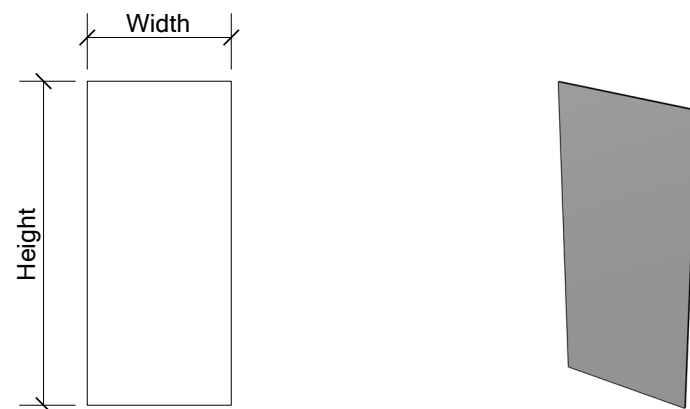

Guarantees

Warranty against defects 20 years*
 Light Fastness Warranty 20 years*
 * conditions apply

Environmental Attributes

- Declare Certification
- LCB Red List Free
- Phenol And Formaldehyde Free
- Low VOC
- CDPH Compliance
- Complies with Building Standards



Patterns

Chevron

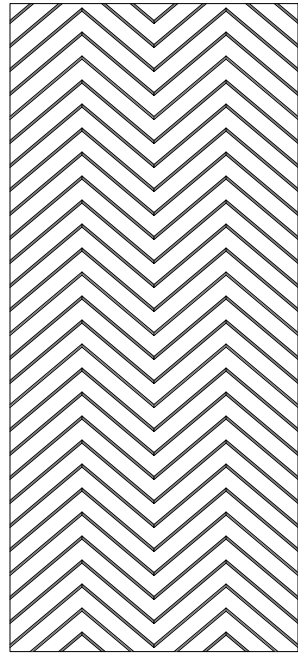

Pennant

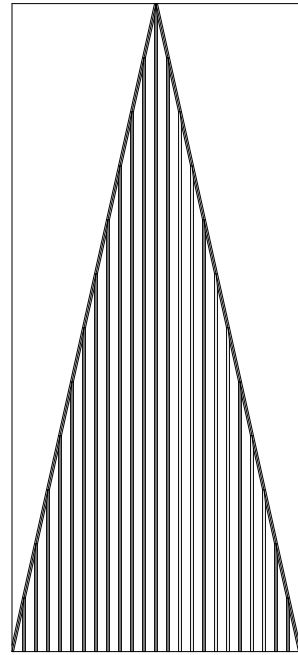

Summit

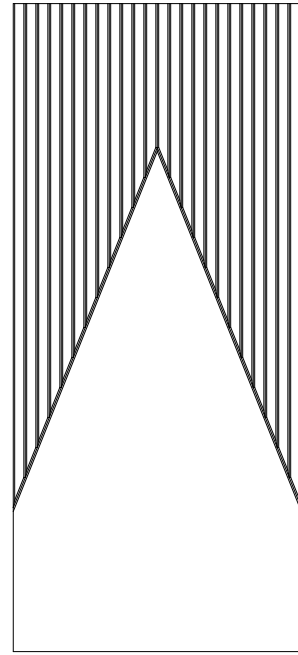

Arch

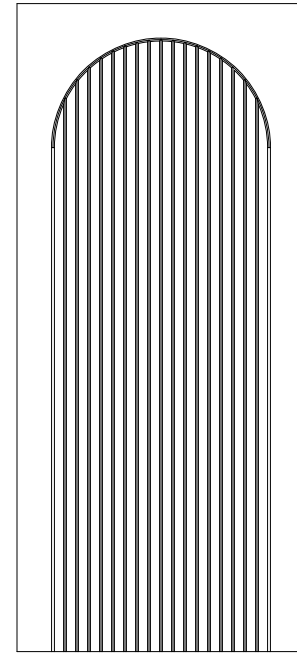

Metropolis

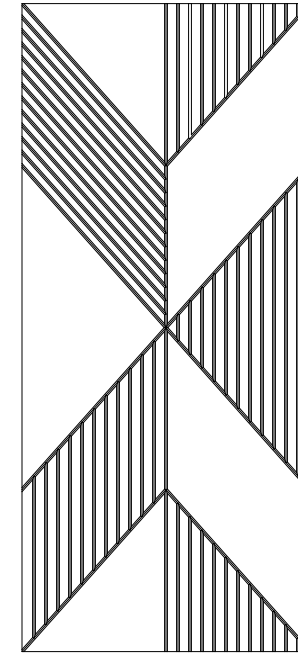

Track

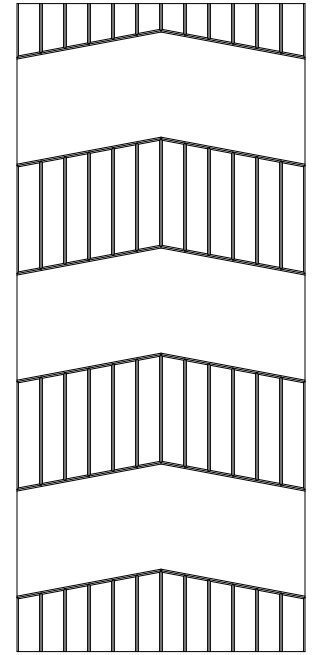

Pulse

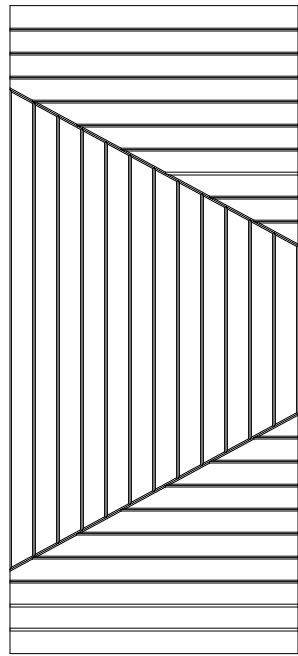

Harlequin

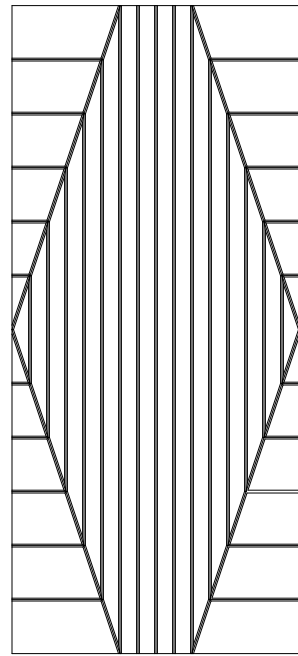

Spirograph

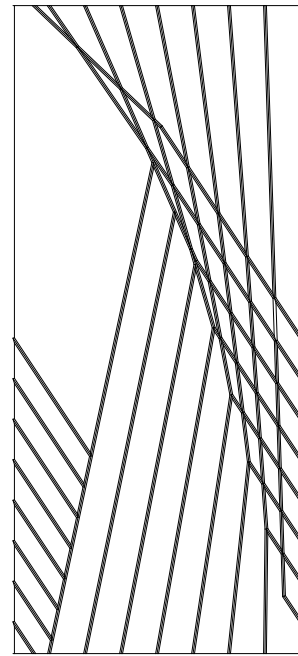

Prism

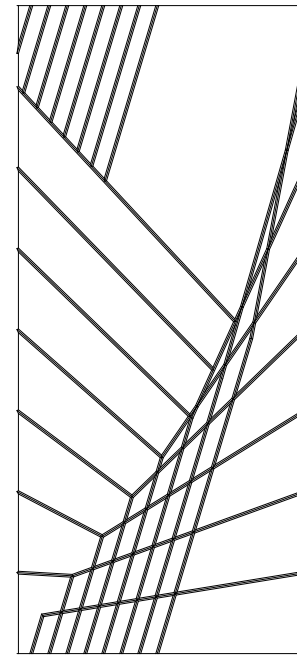

Rowhouse

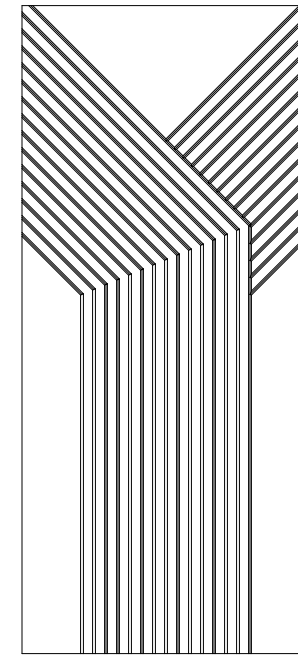

Intersect

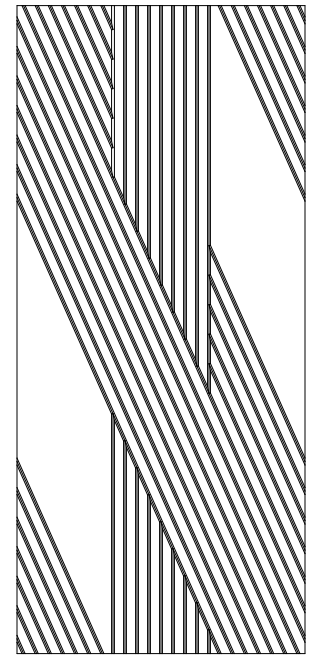

Patterns

Knit

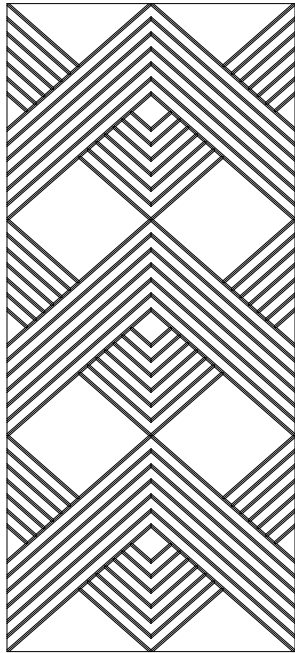

Lattice

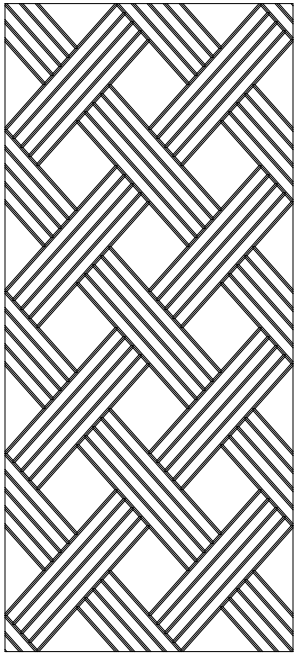

Maze

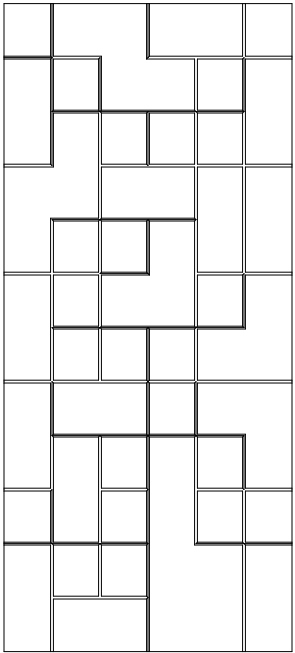

Formula

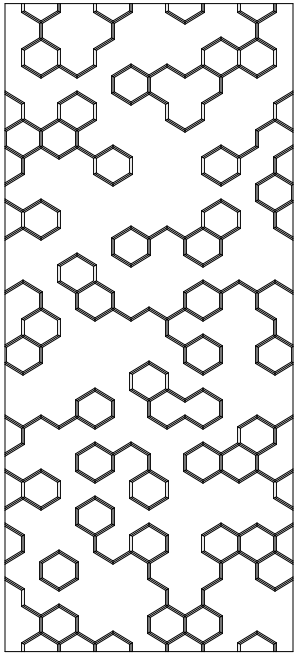

Fineline

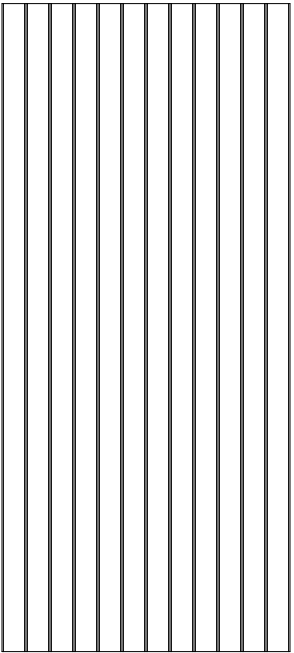

Diagonal

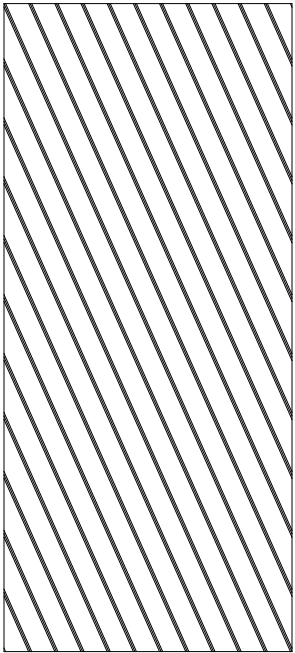

Trellis

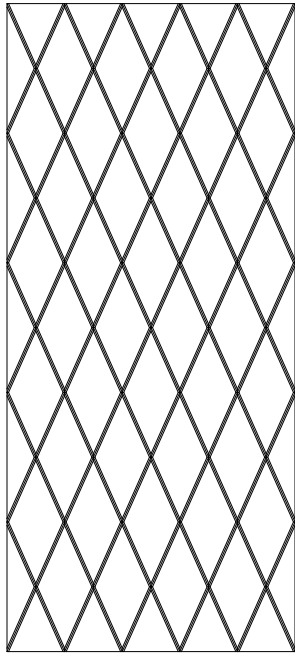

Wavelength

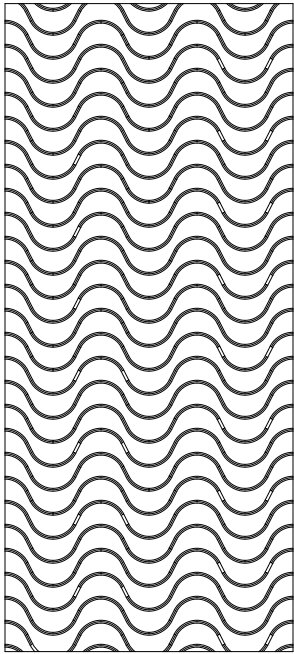

Chevron Pattern

Recommended Layout

Chevron

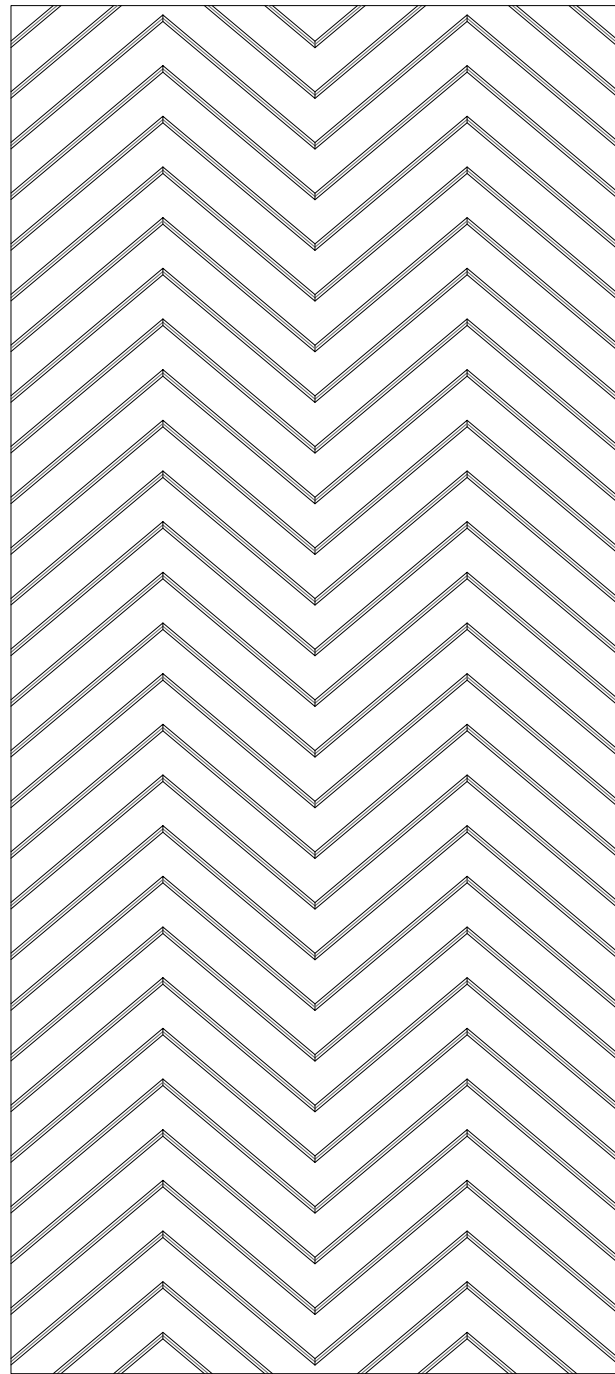

Layout 1

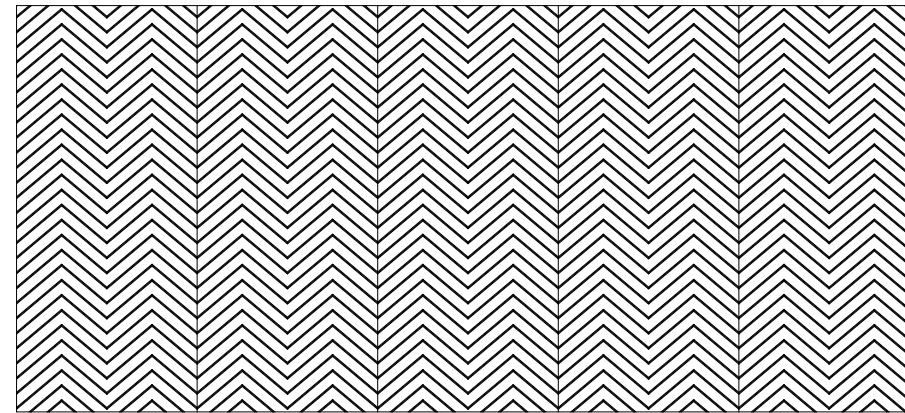

Layout 2

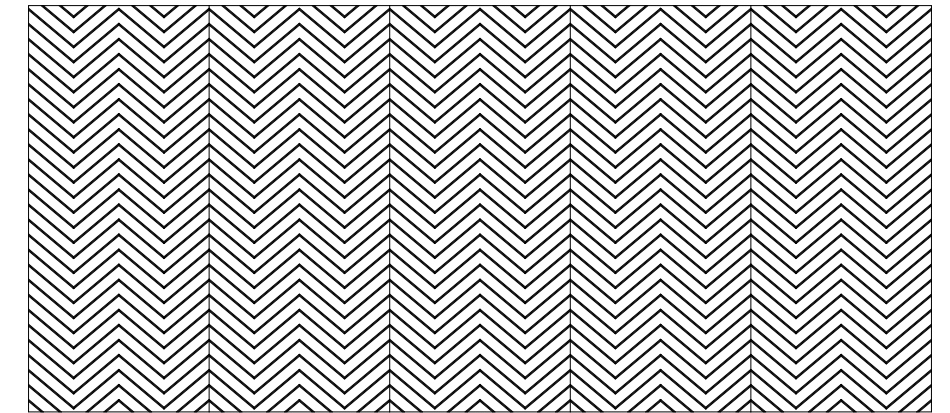

Layout 3

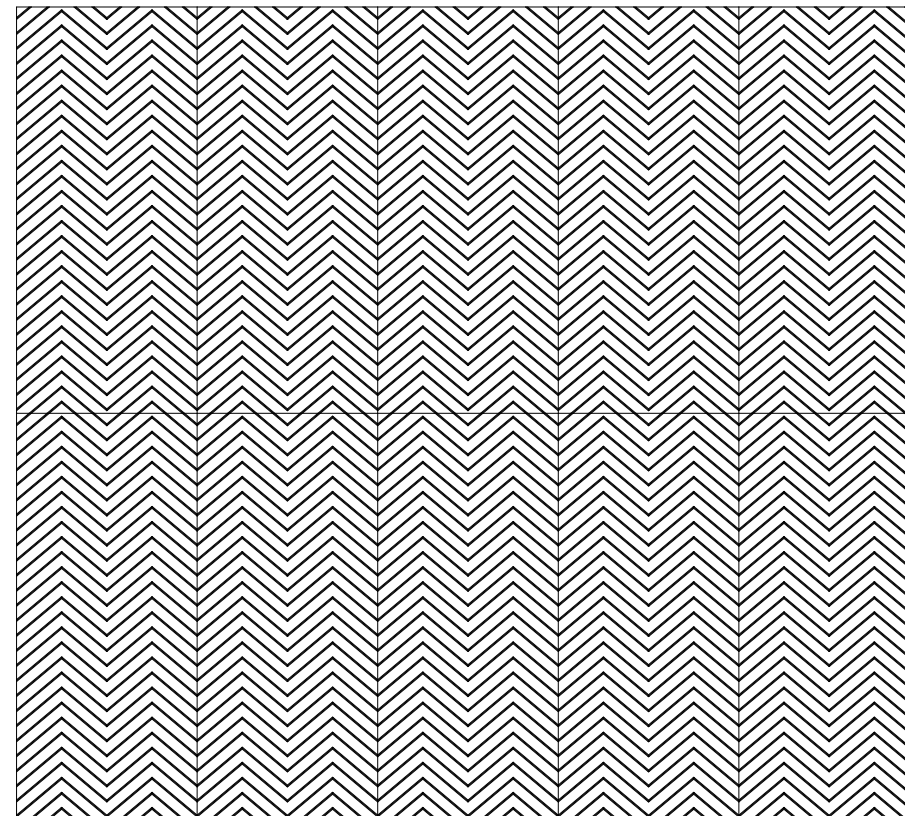

Layout 4

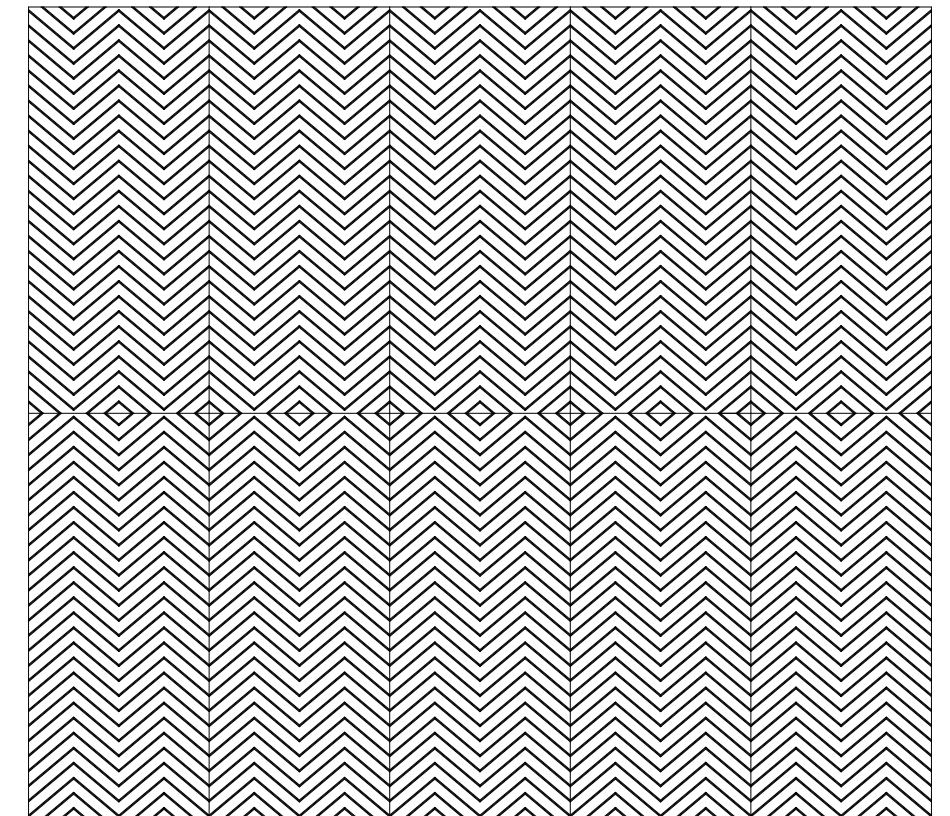

Pennant Pattern

Recommended Layout

Pennant

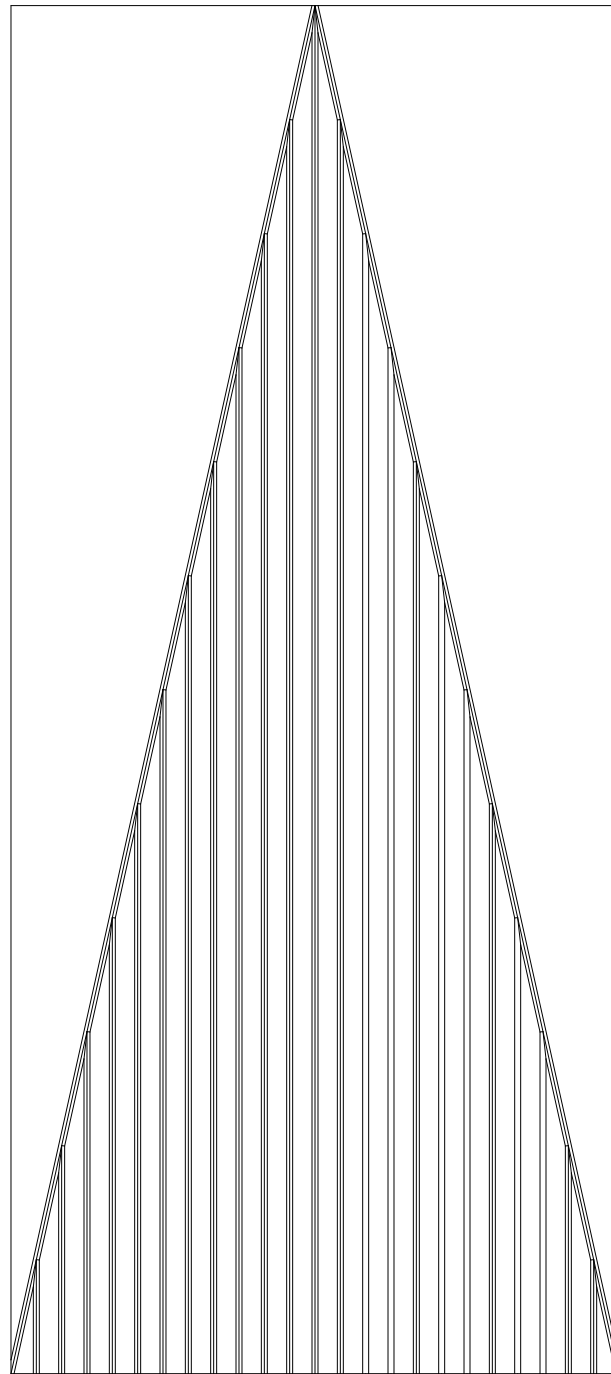

Layout 1

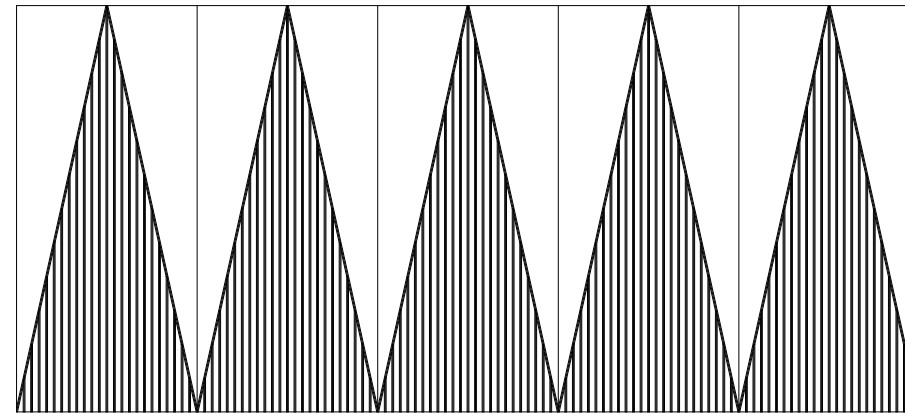

Layout 2

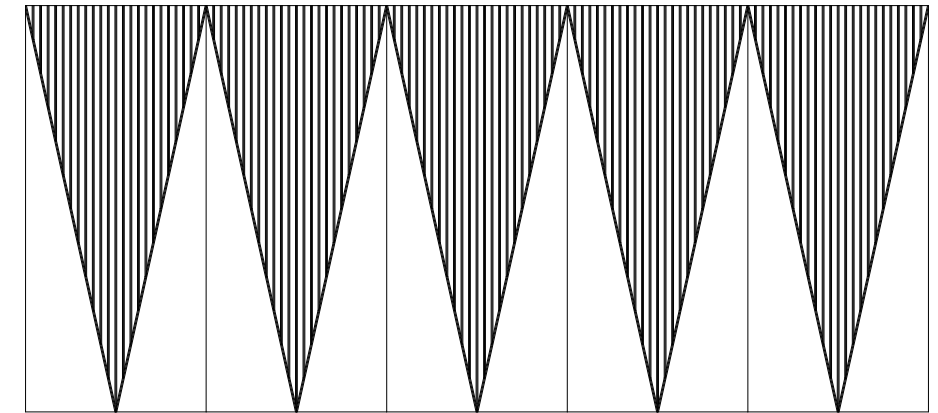

Layout 3

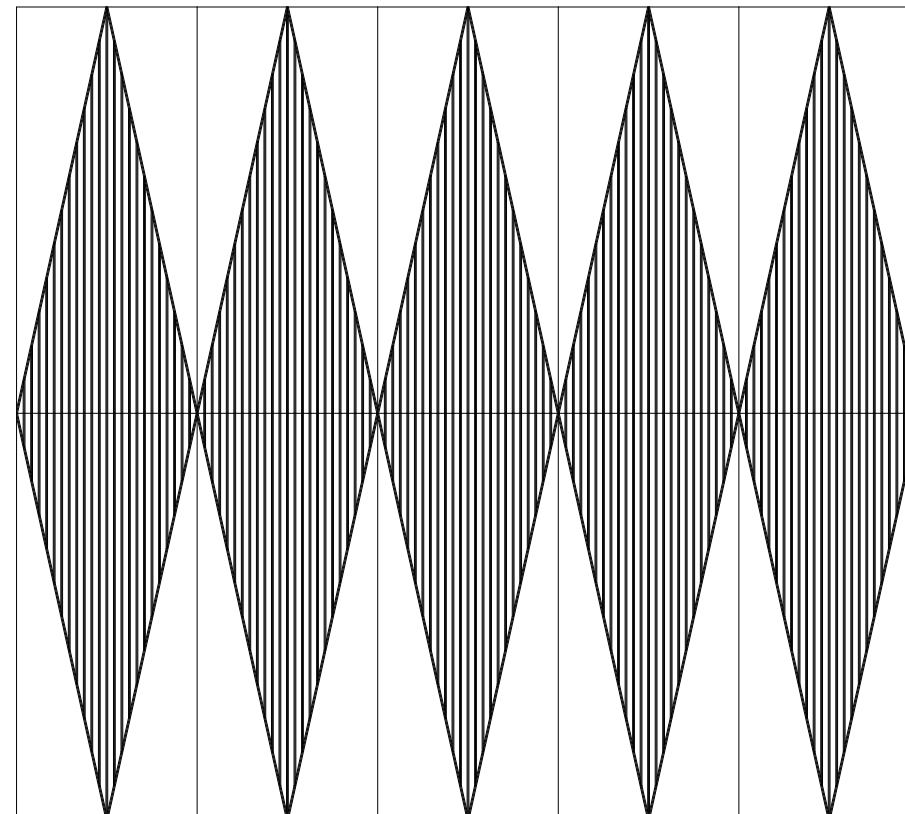

Layout 4

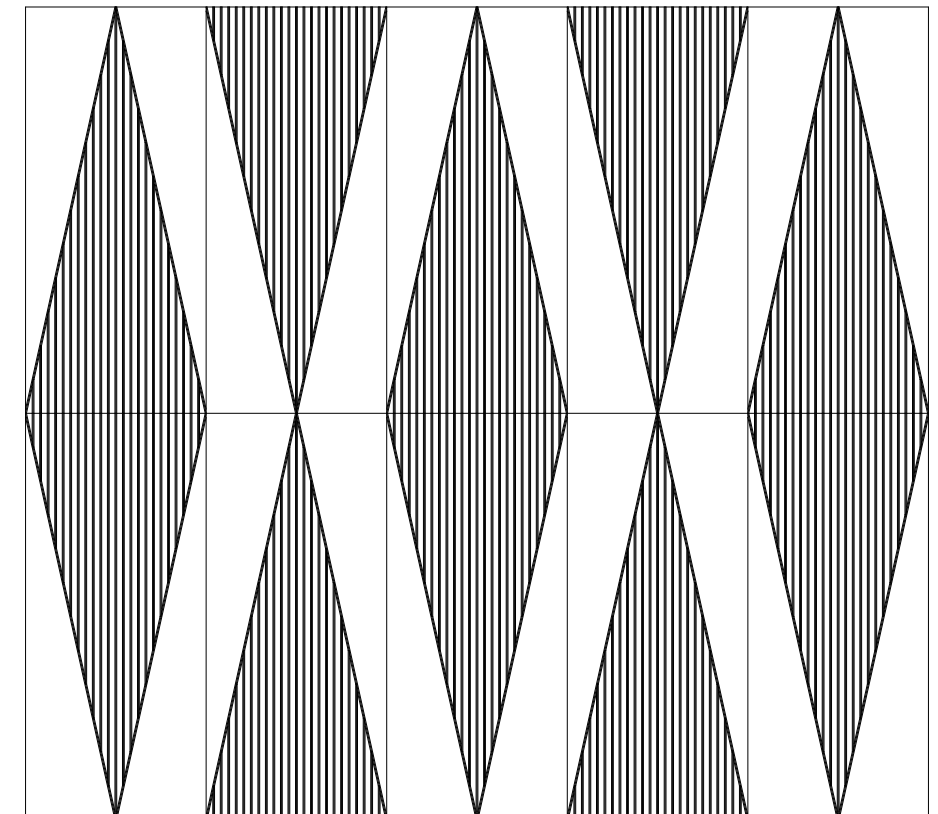

Summit Pattern

Recommended Layout

Summit

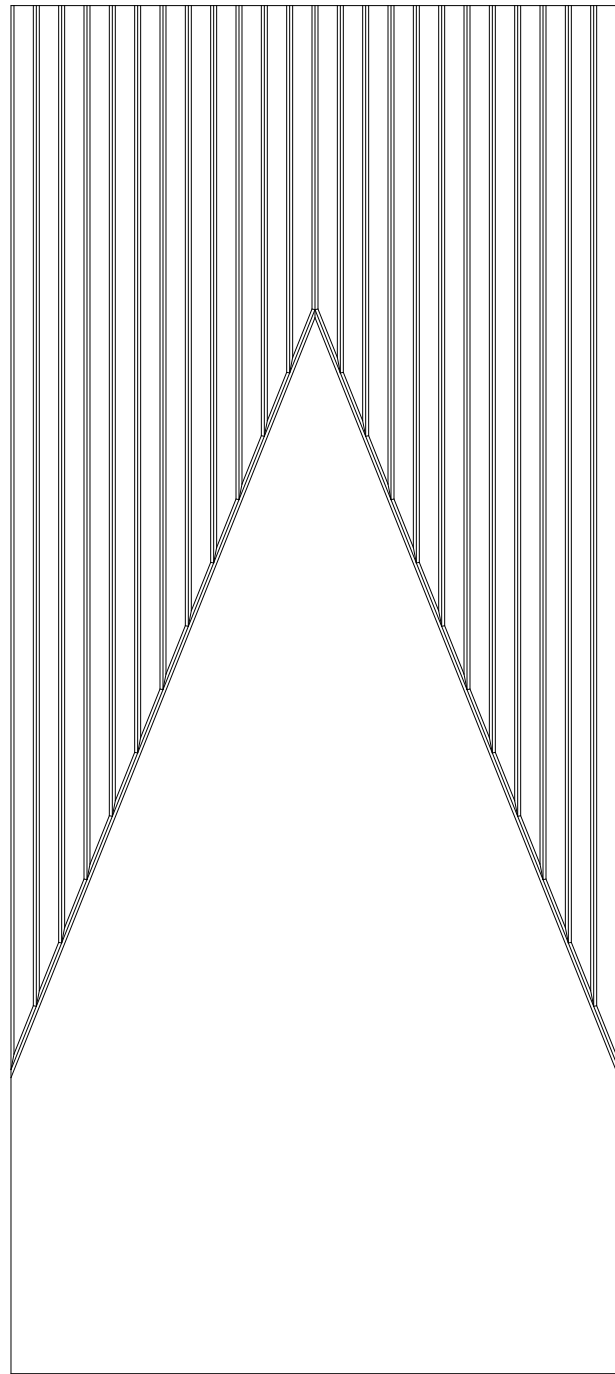

Layout 1

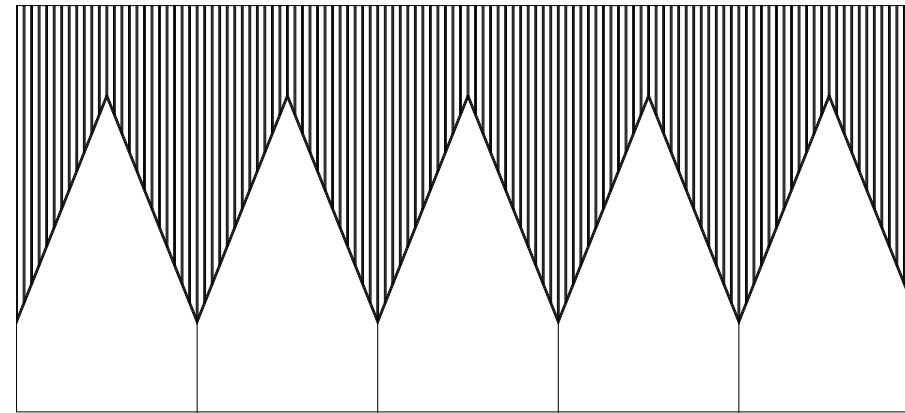

Layout 2

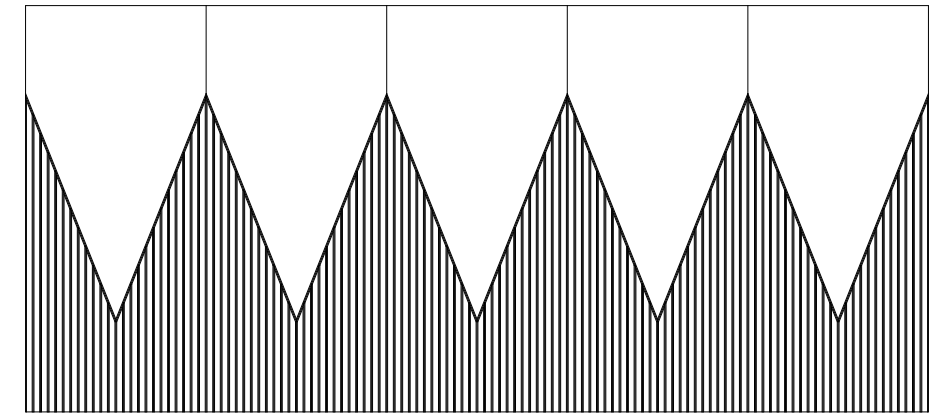

Layout 3

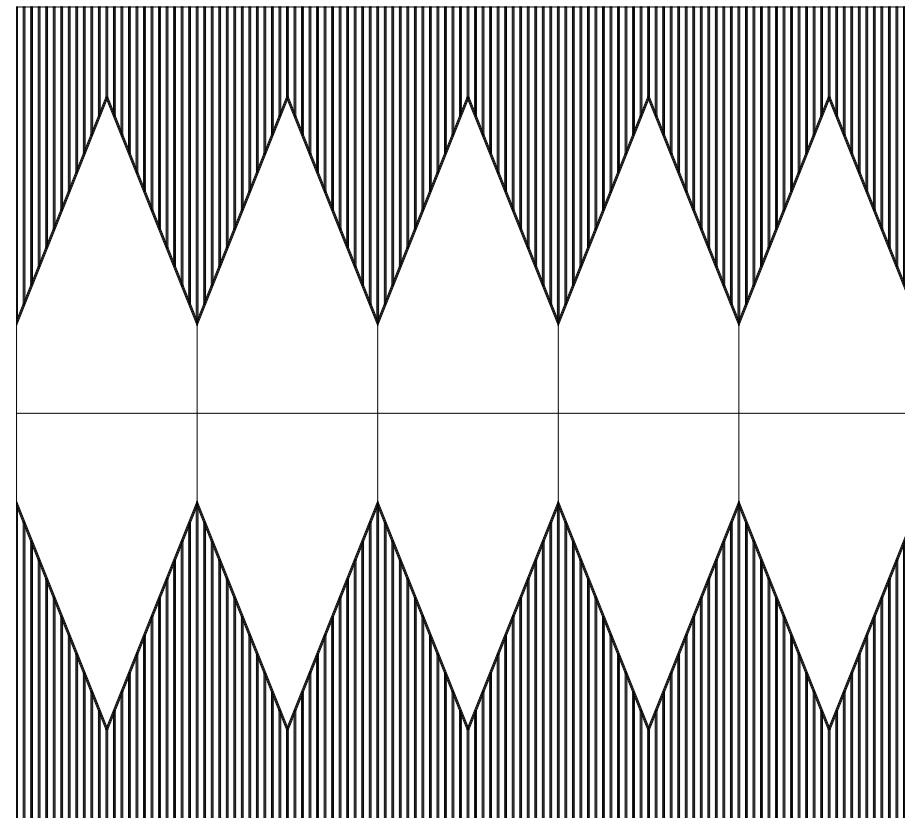

Layout 4

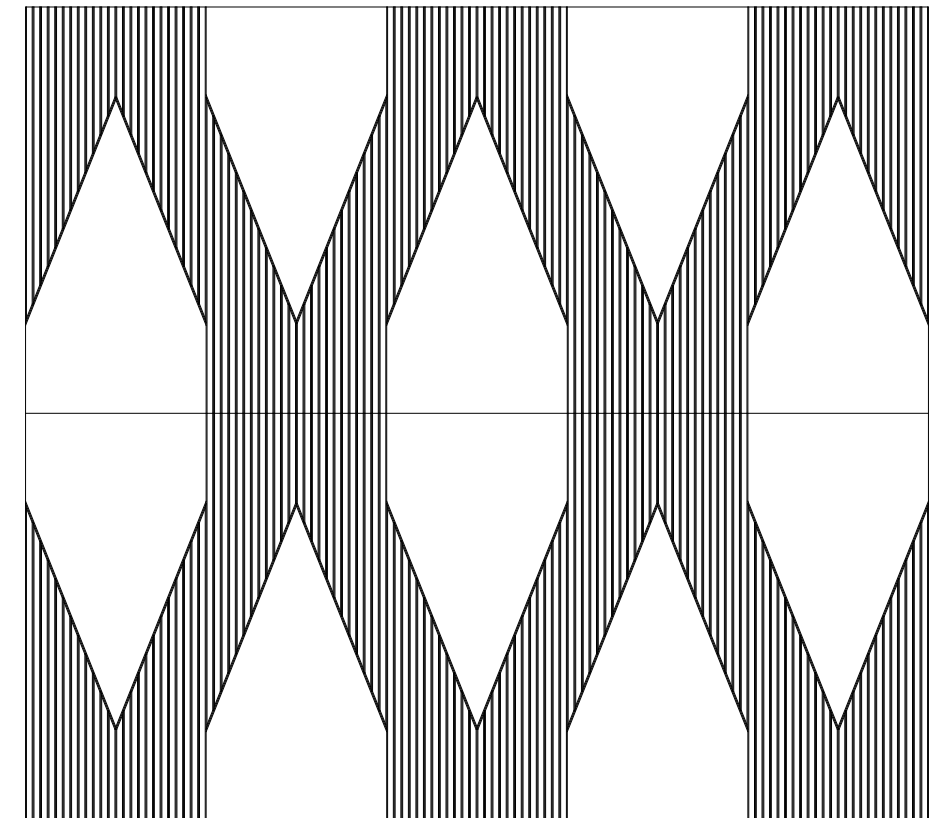

Arch Pattern

Recommended Layout

Arch

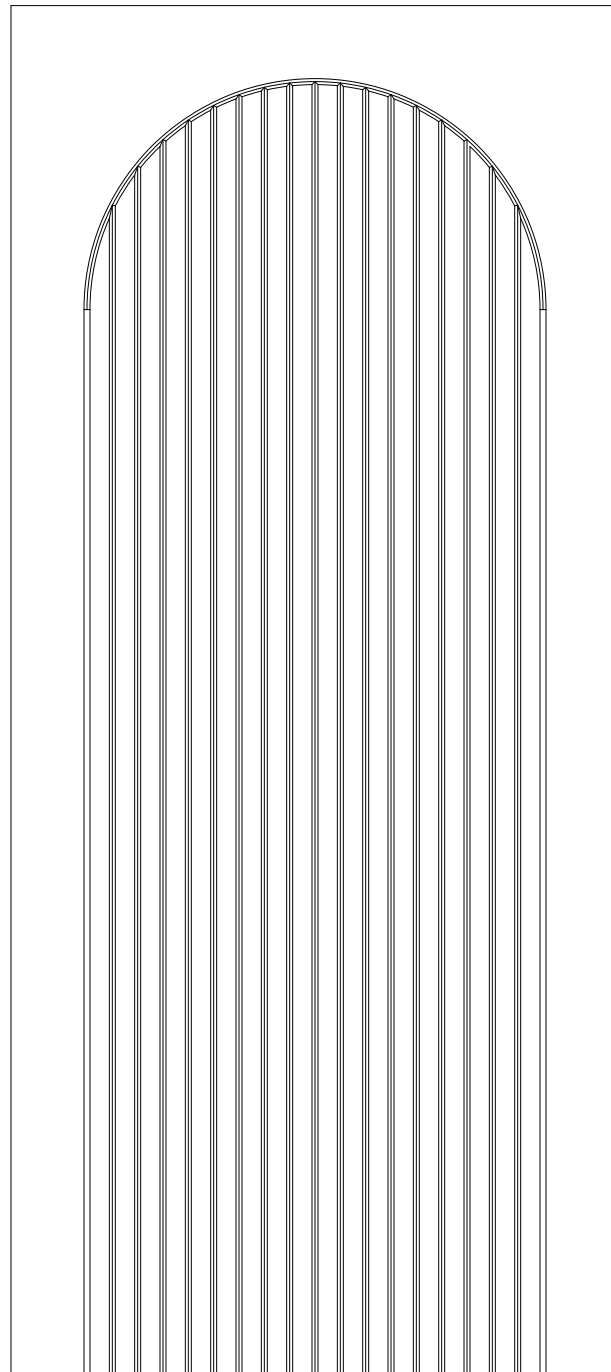

Layout 1

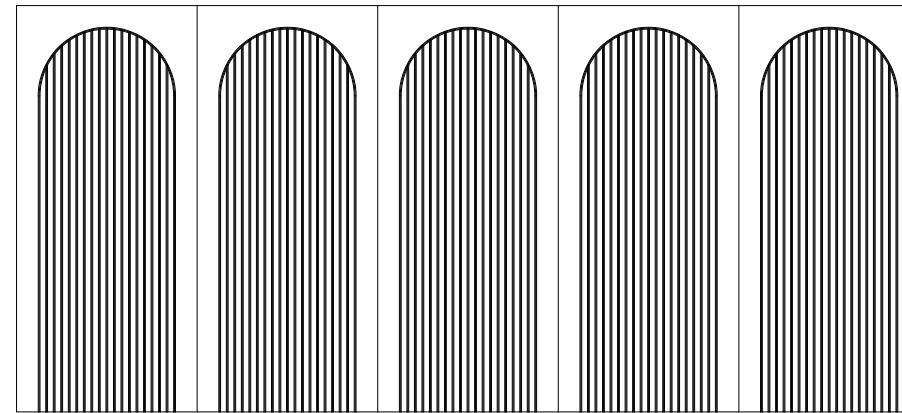

Layout 2

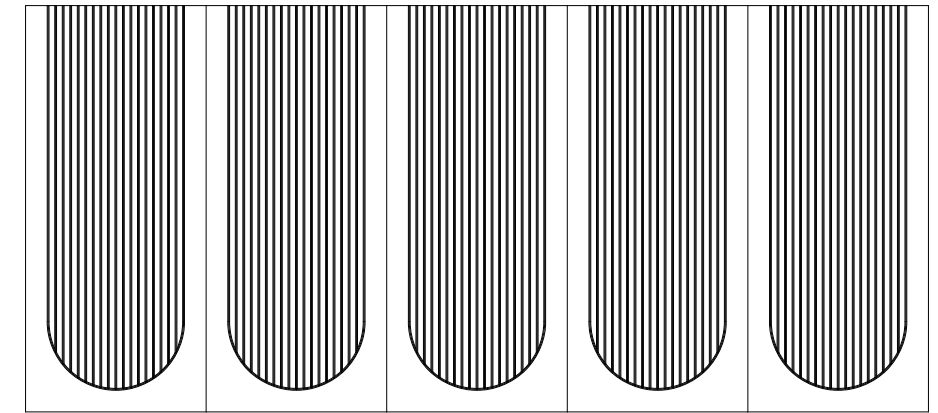

Layout 3

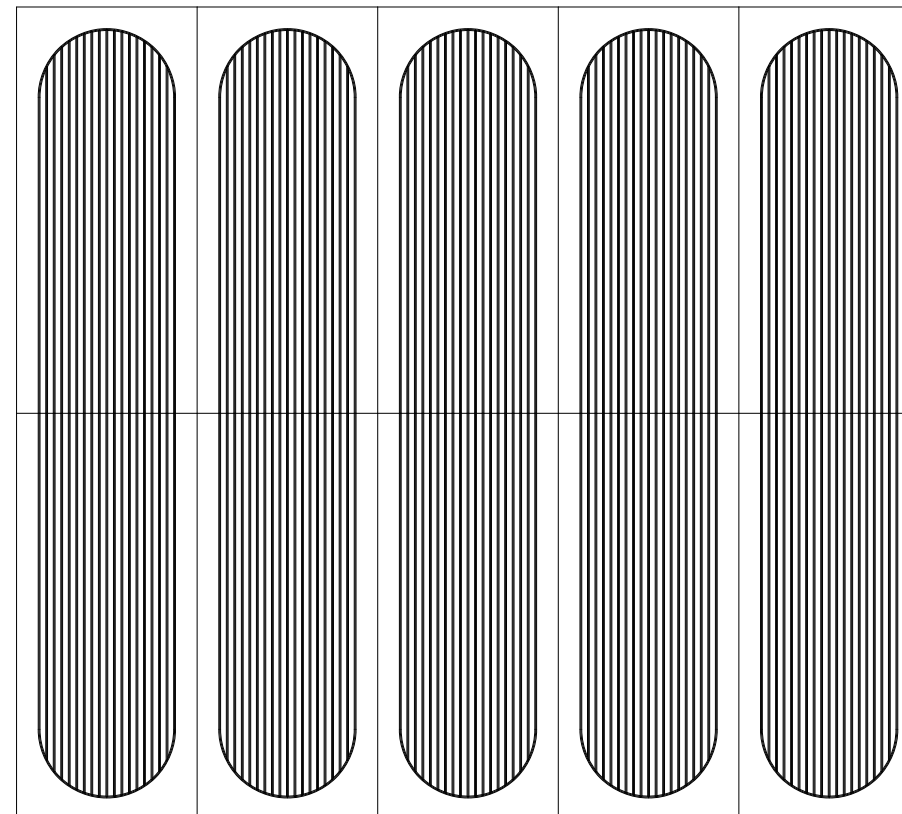

Layout 4

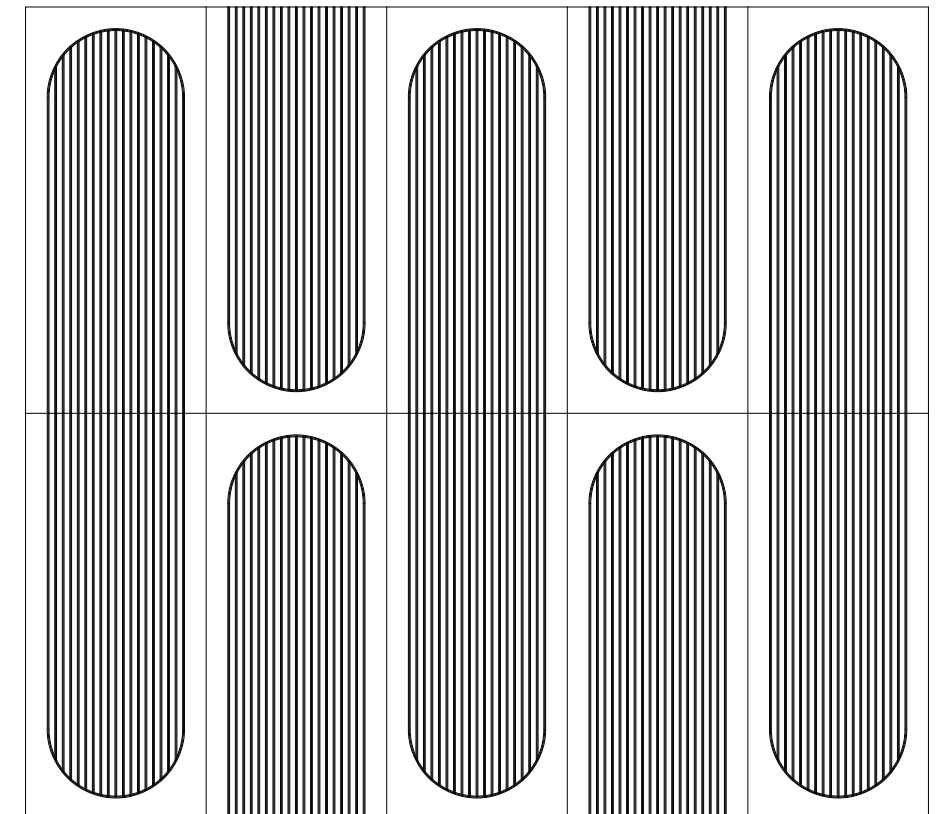

Metropolis Pattern

Recommended Layout

Metropolis

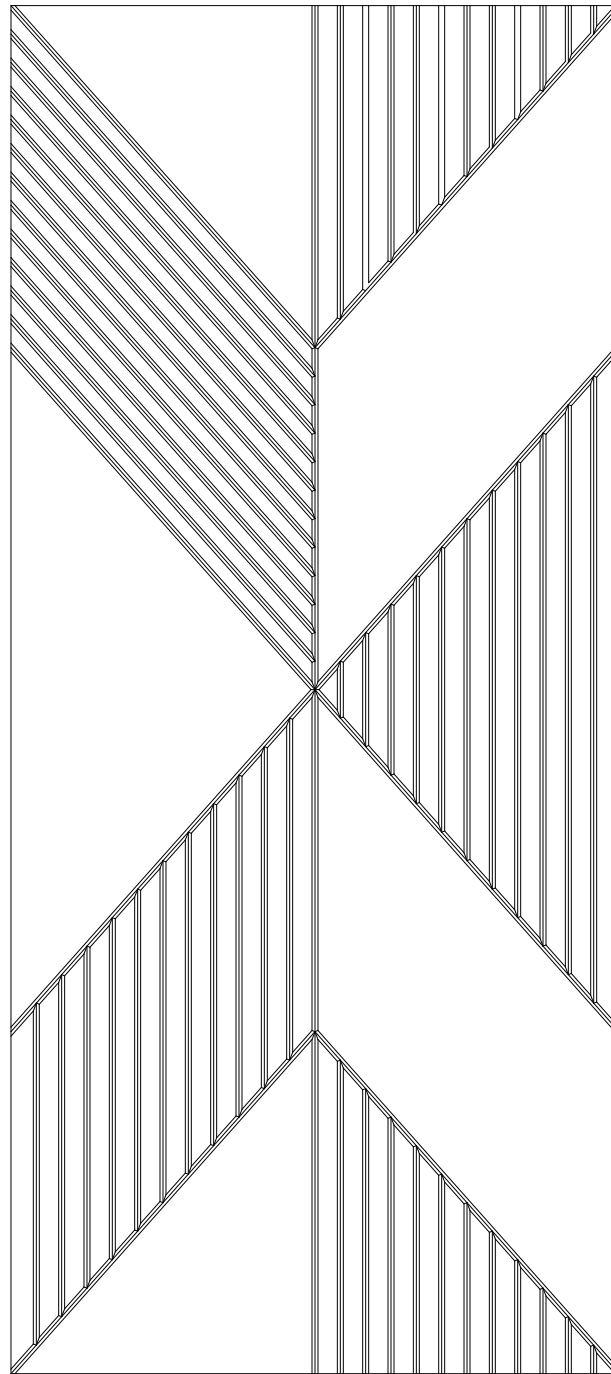

Layout 1

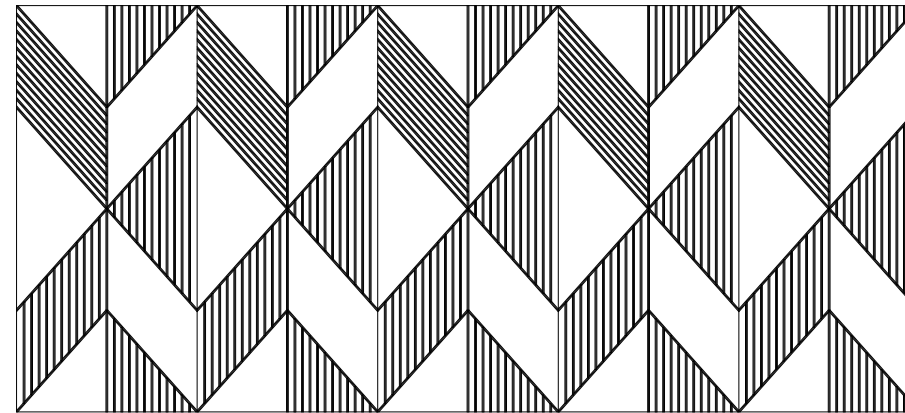

Layout 2

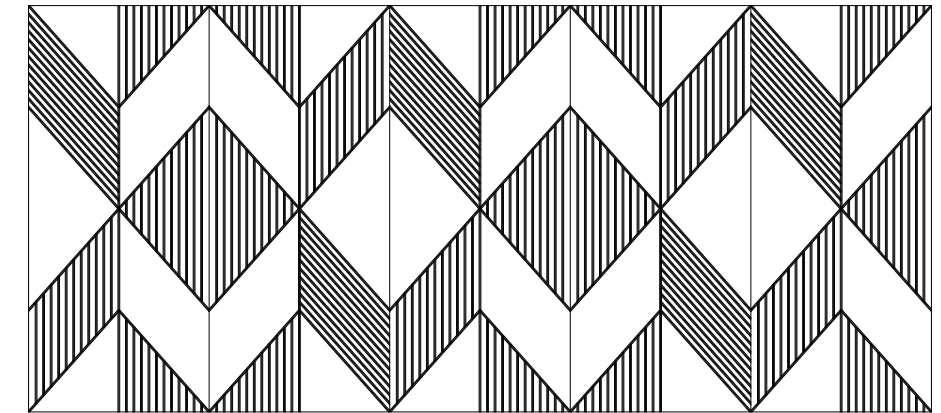

Layout 3

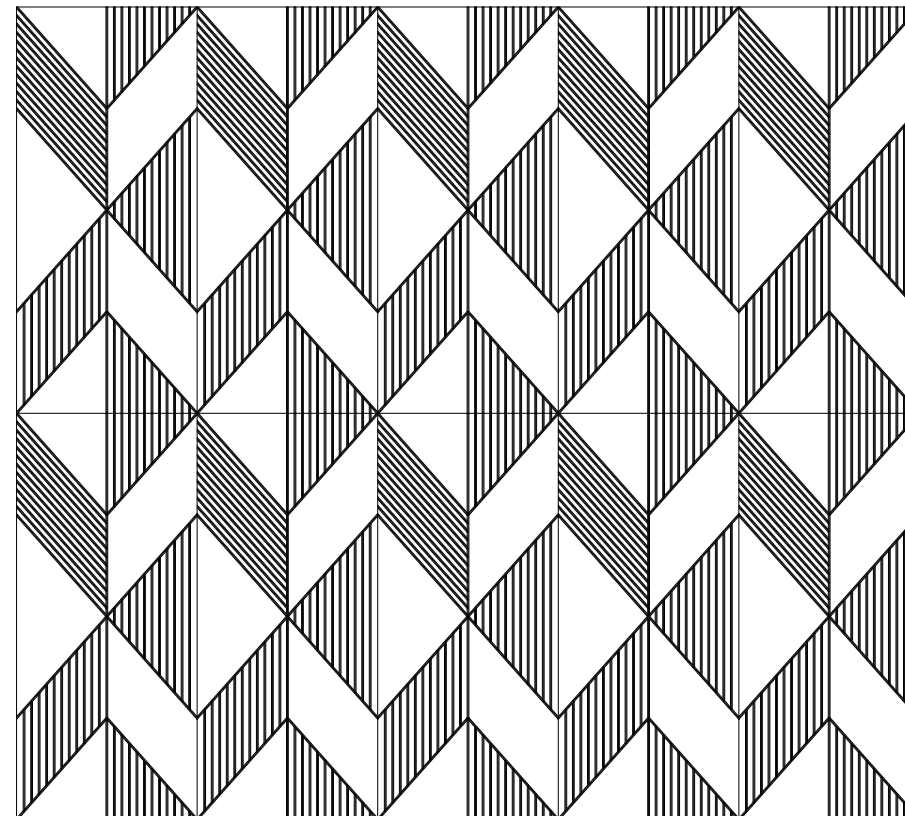

Layout 4

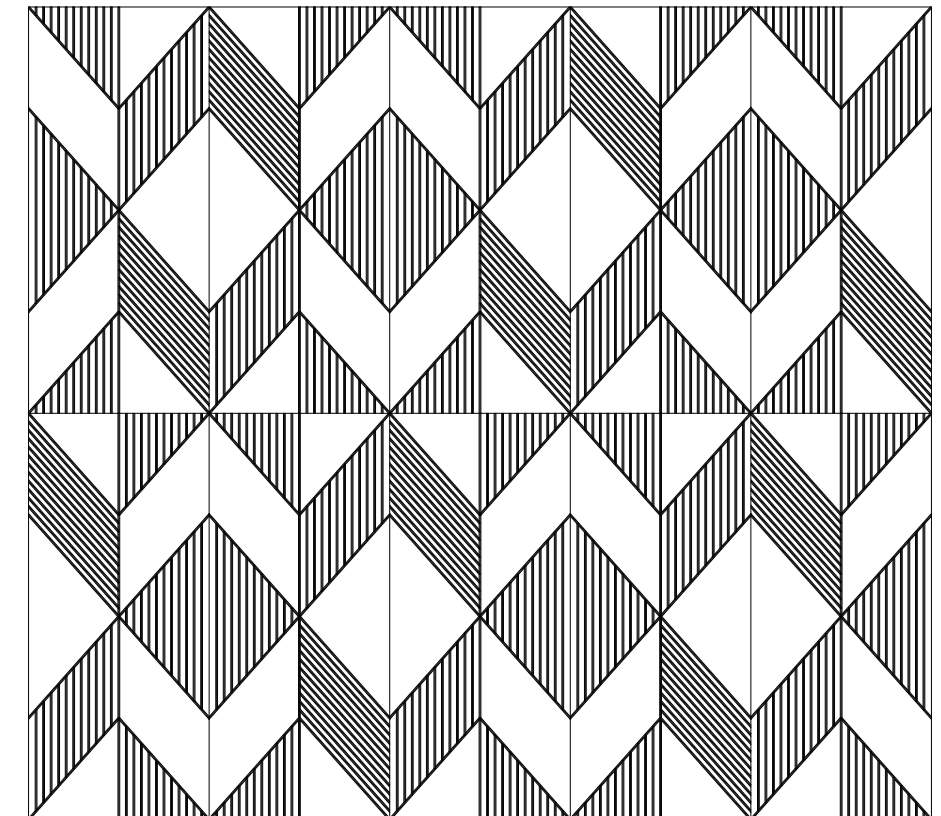

Track Pattern

Recommended Layout

Track

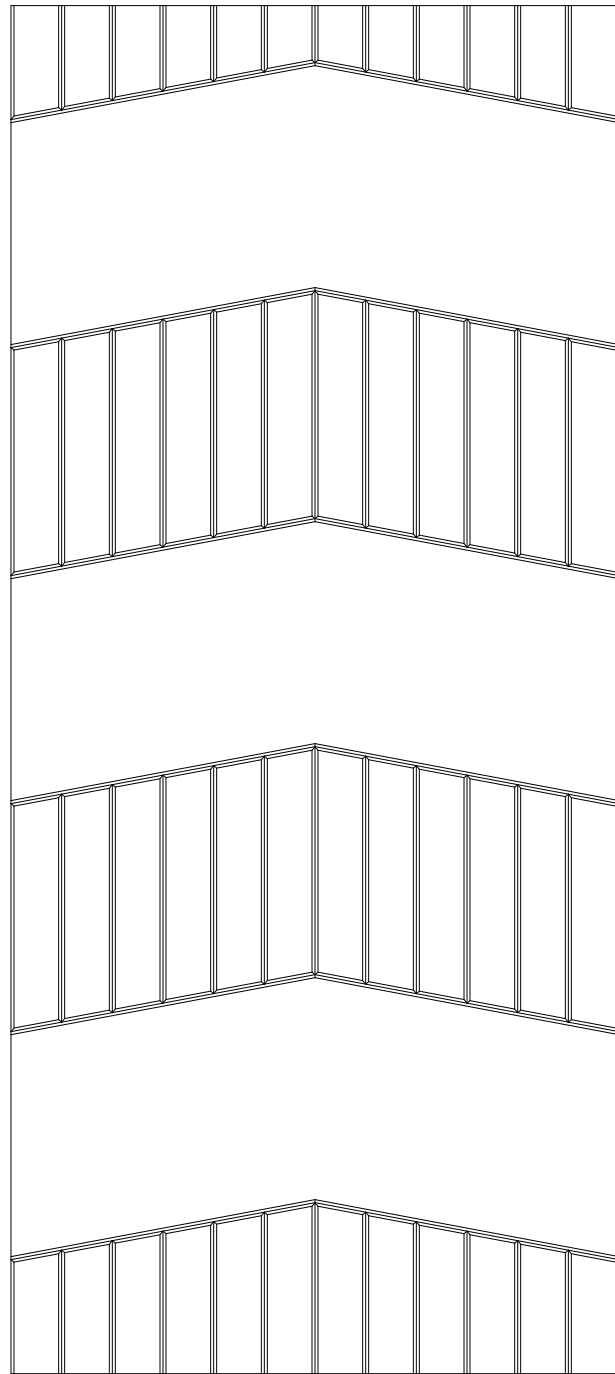

Layout 1

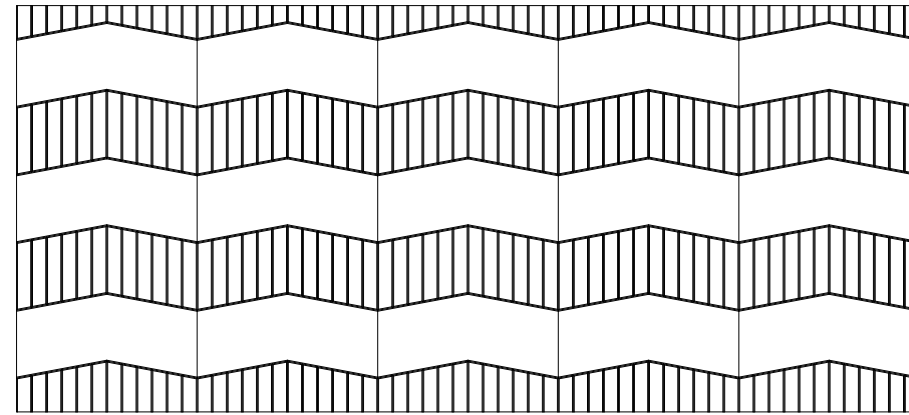

Layout 2

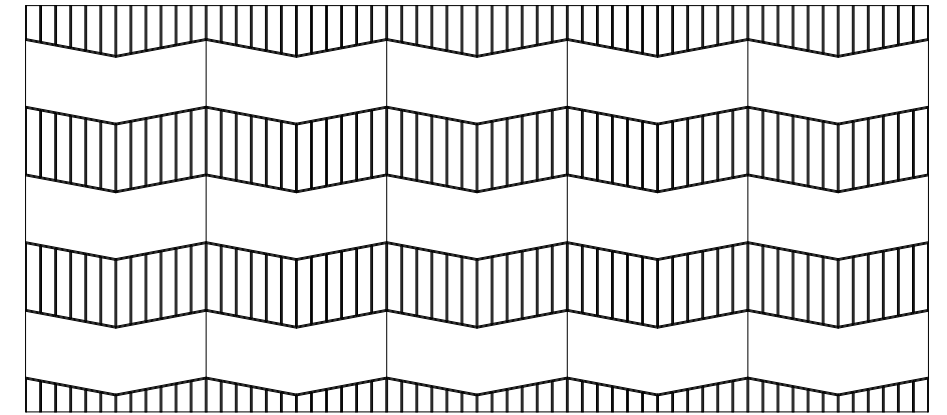

Layout 3

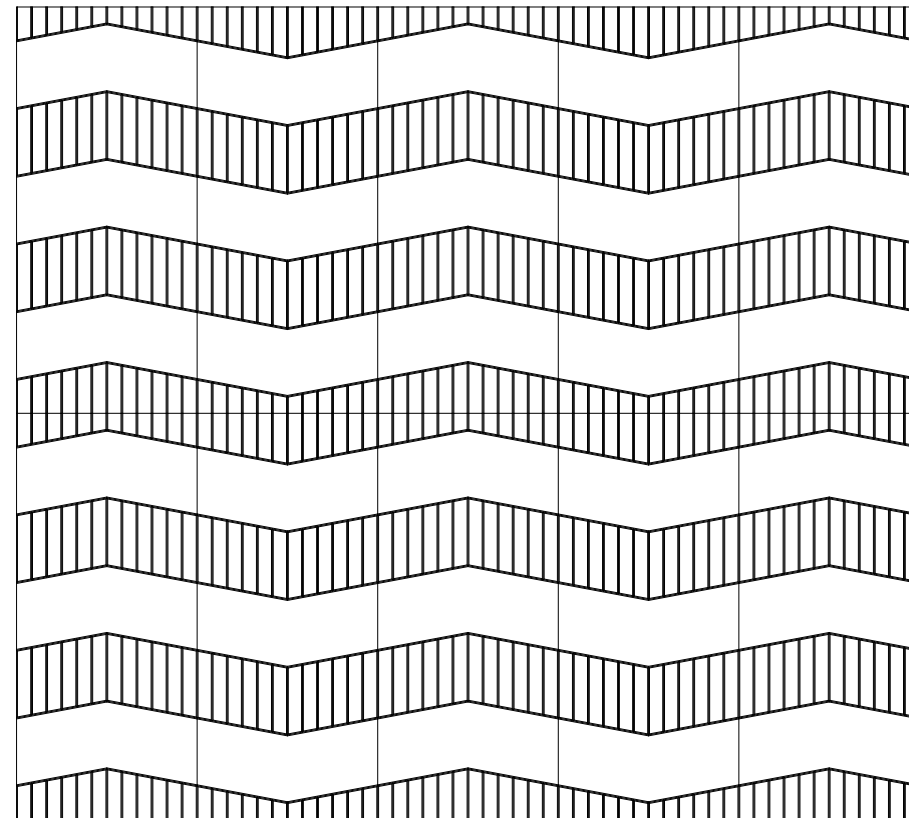

Layout 4

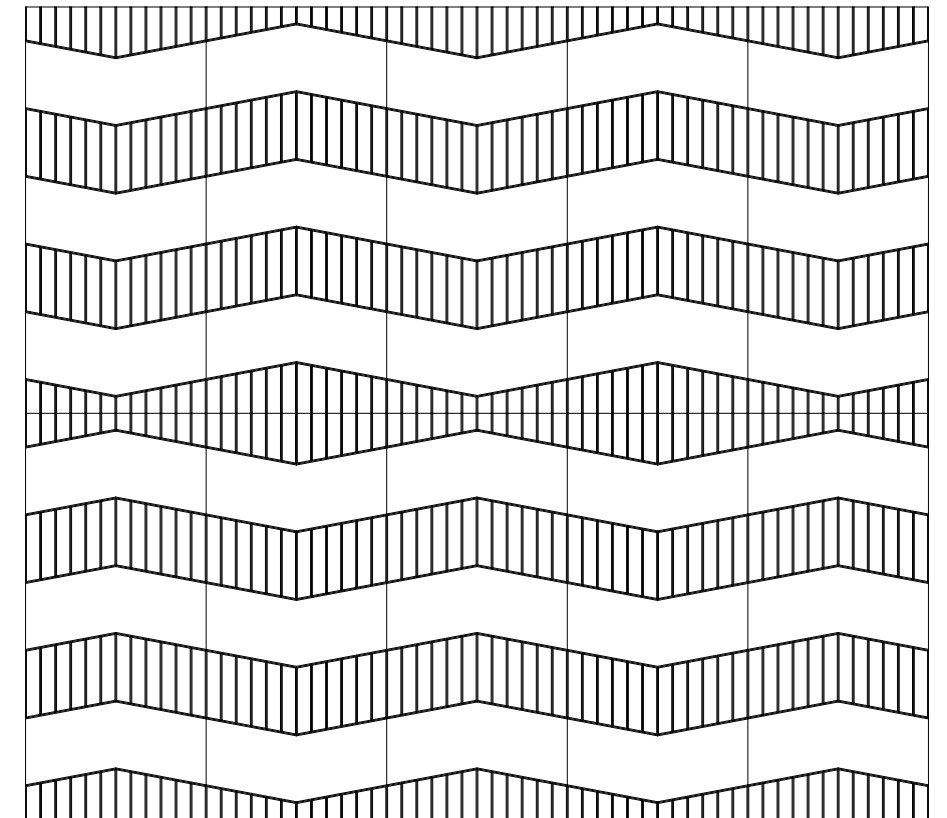

Pulse Pattern

Recommended Layout

Pulse

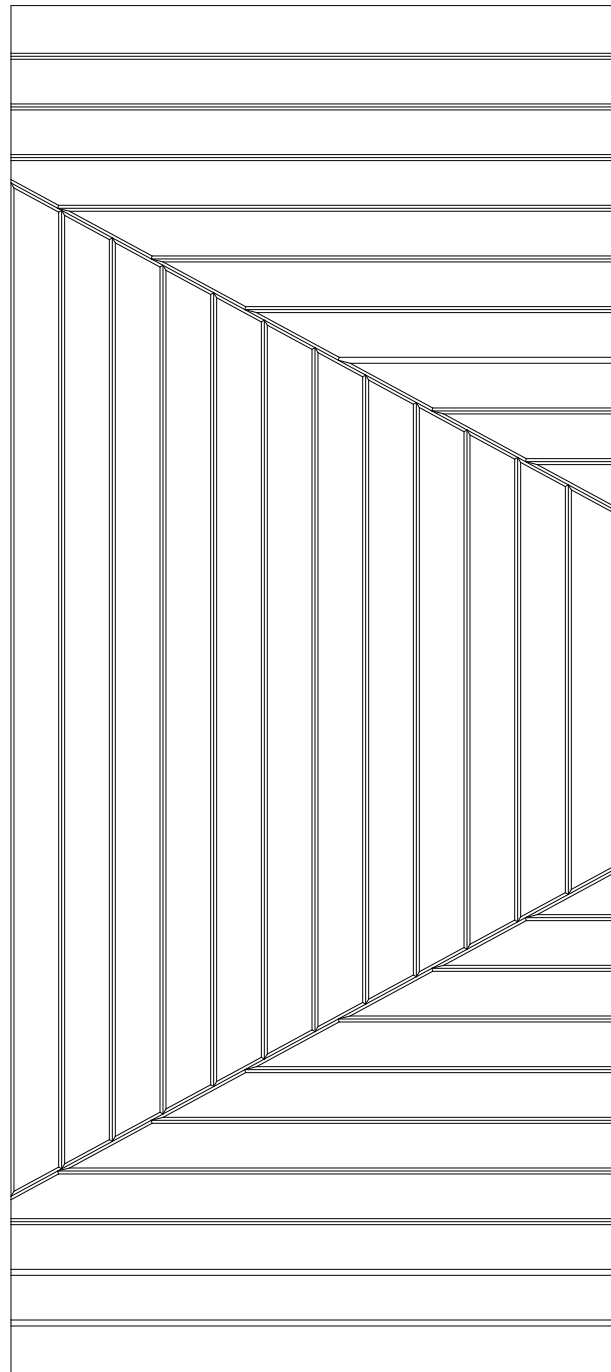

Layout 1

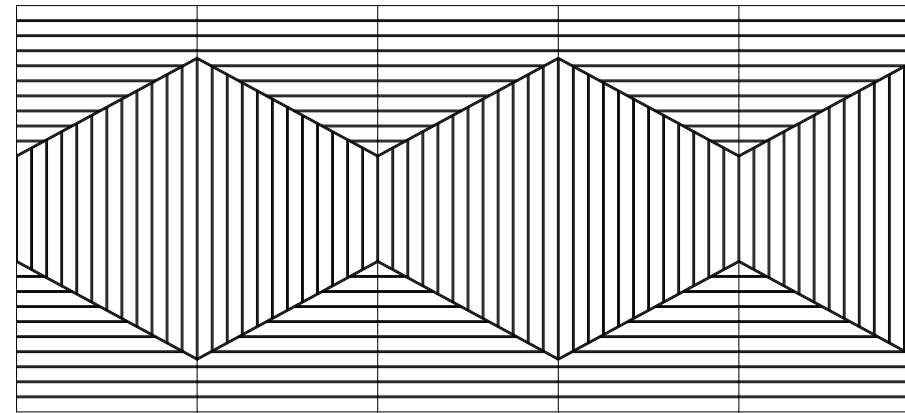

Layout 2

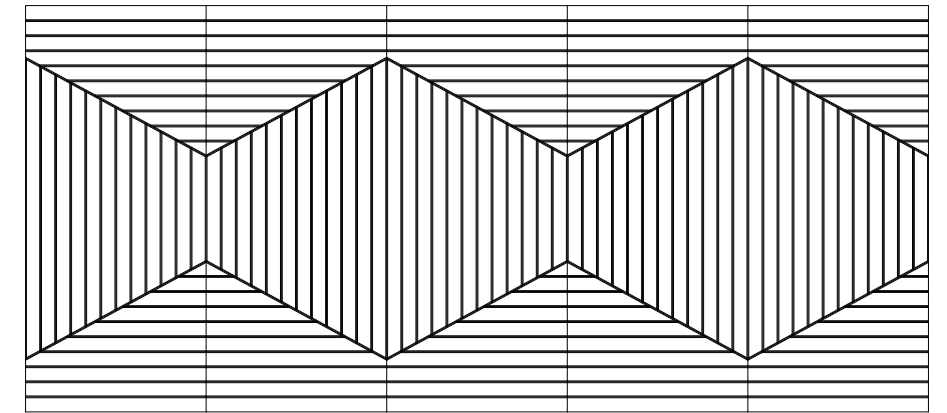

Layout 3

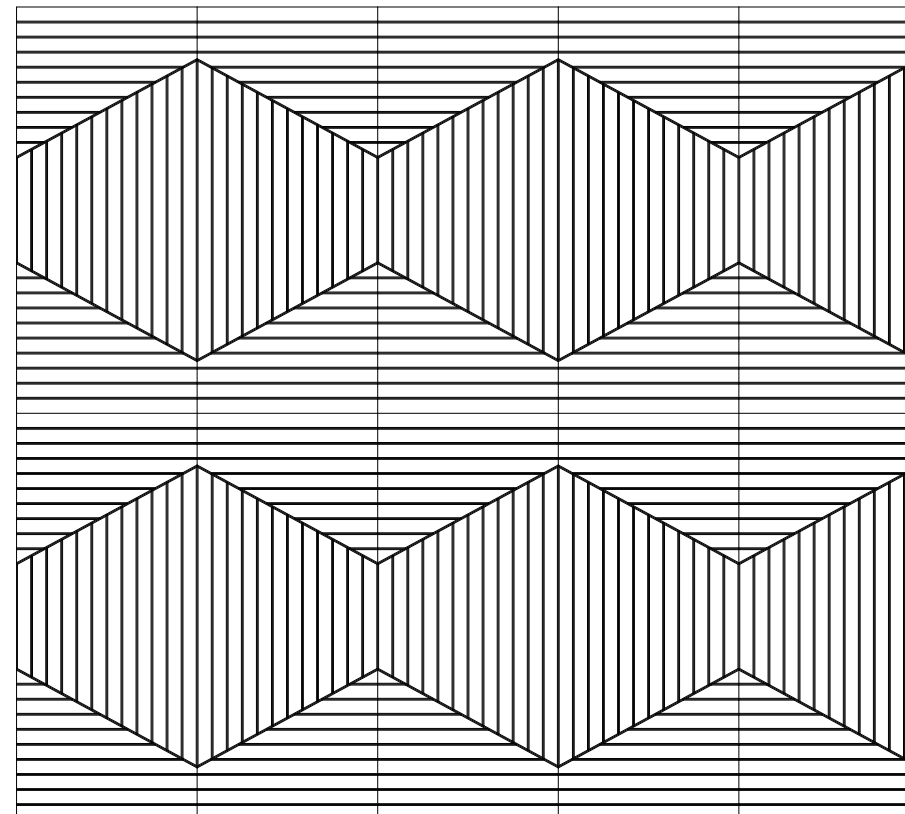

Layout 4

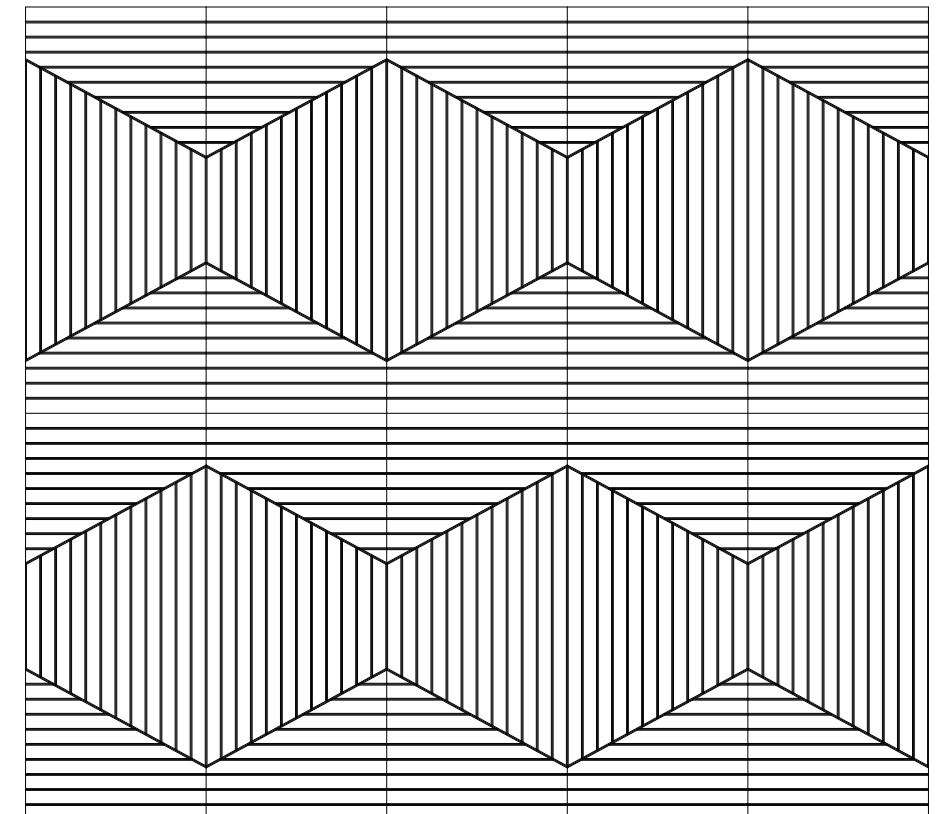

Harlequin Pattern

Recommended Layout

Harlequin

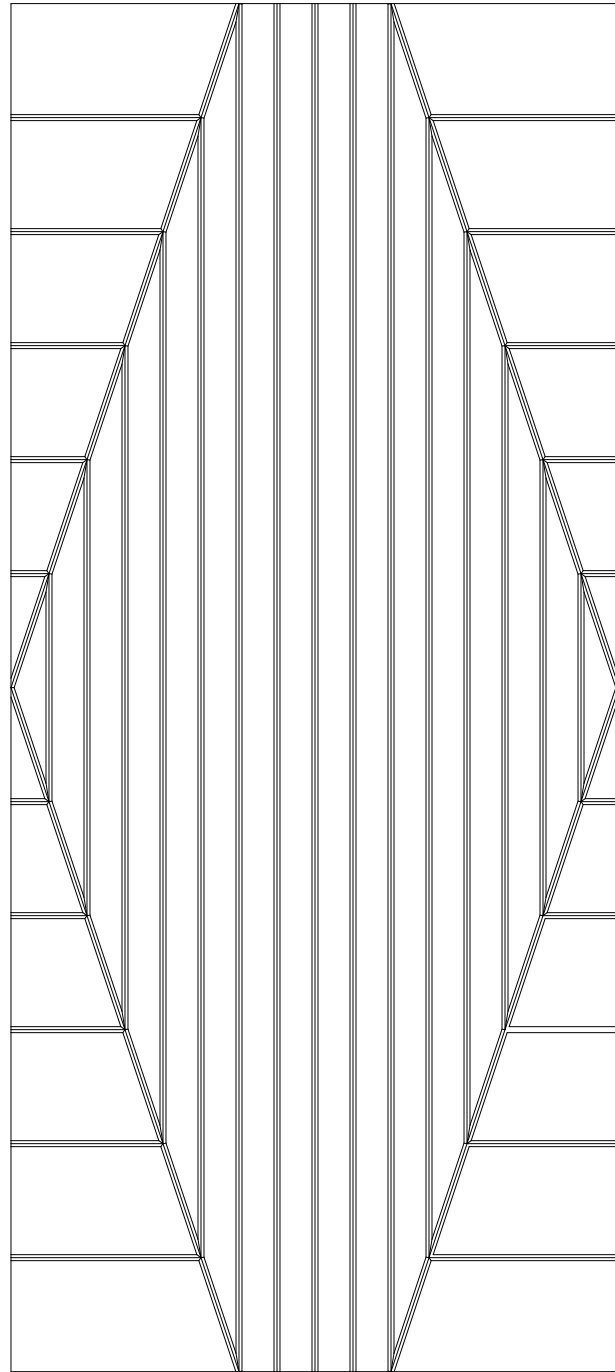

Layout 1

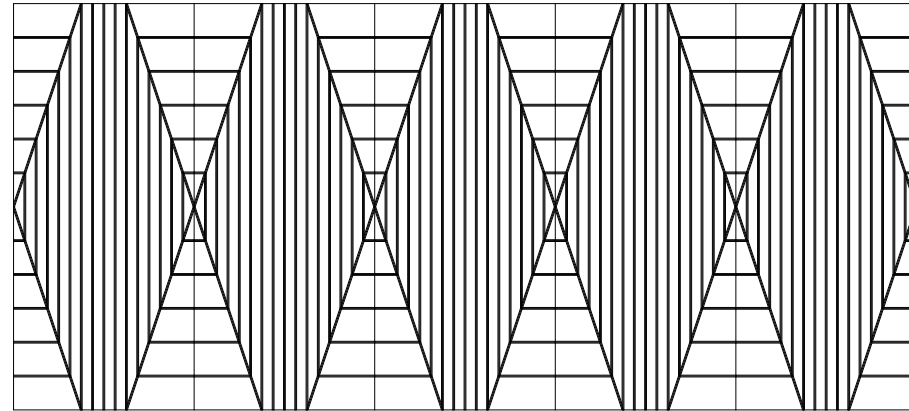

Layout 2

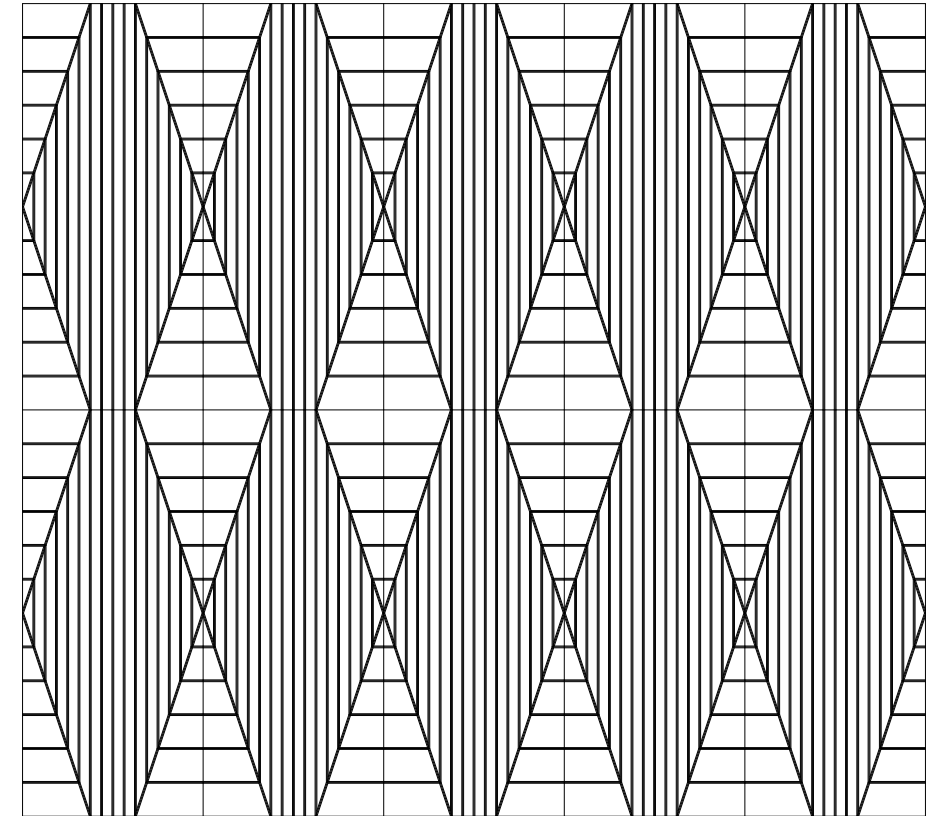

Spirograph Pattern

Recommended Layout

Spirograph

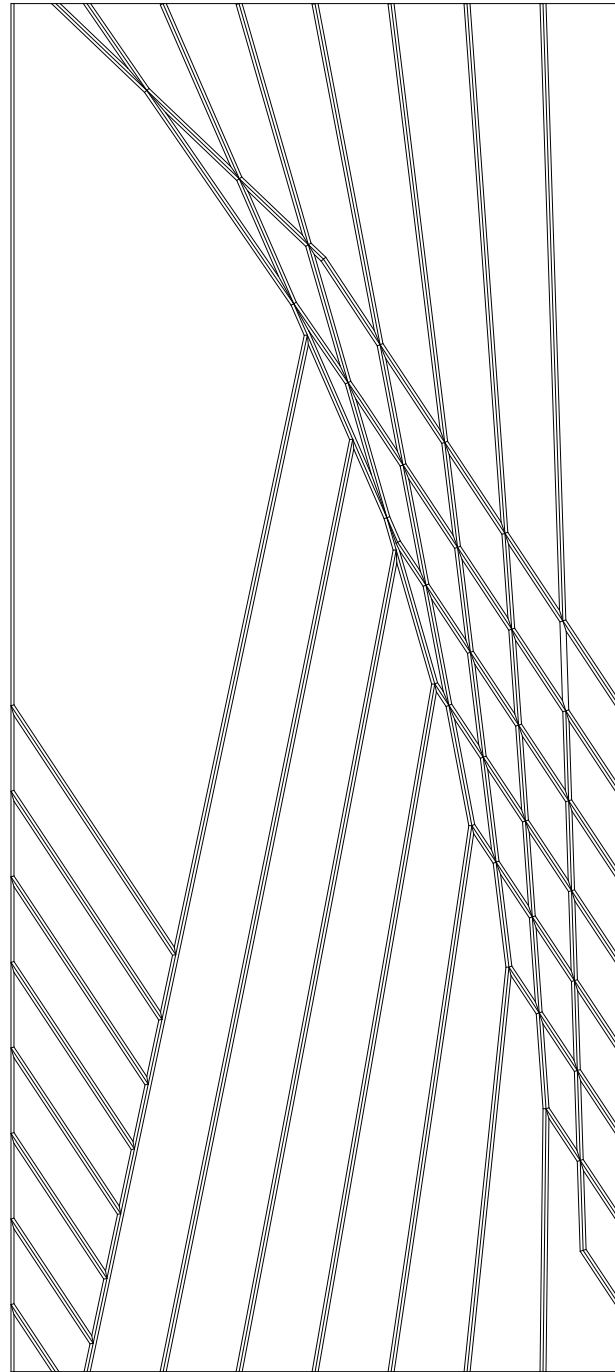

Layout 1

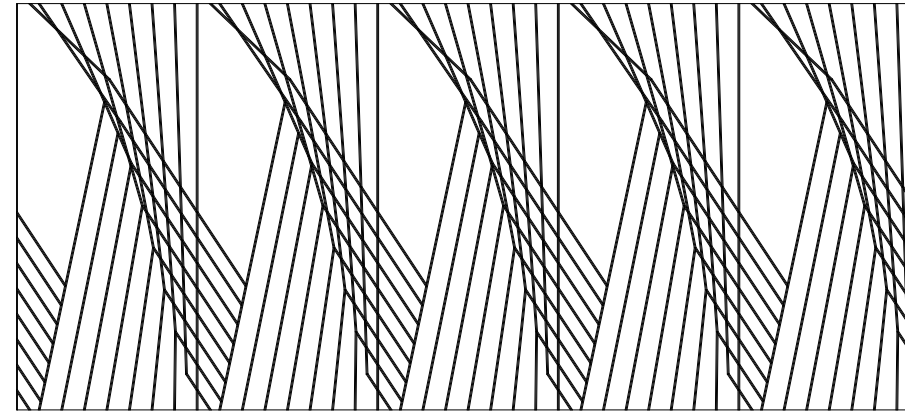

Layout 2

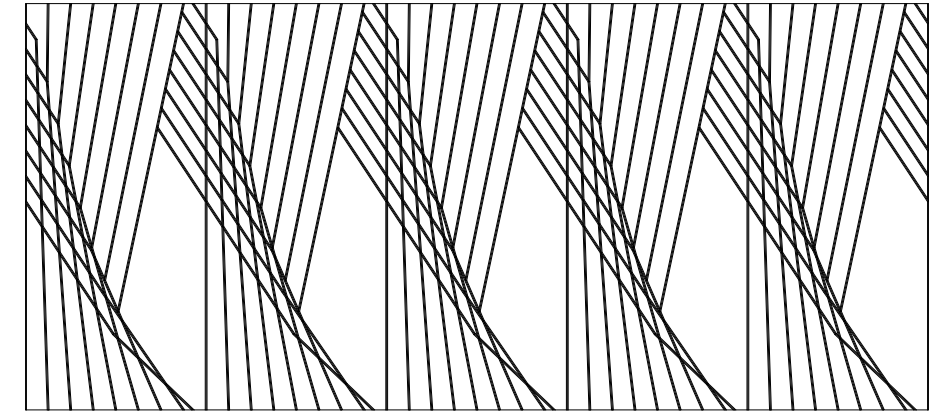

Layout 3

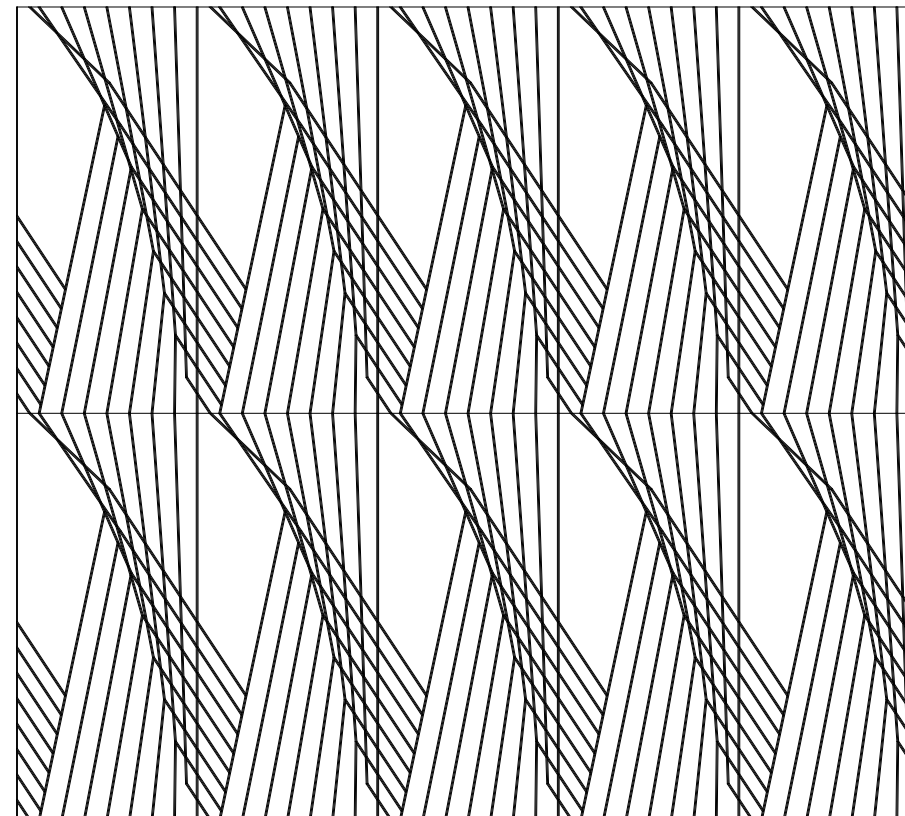

Layout 4

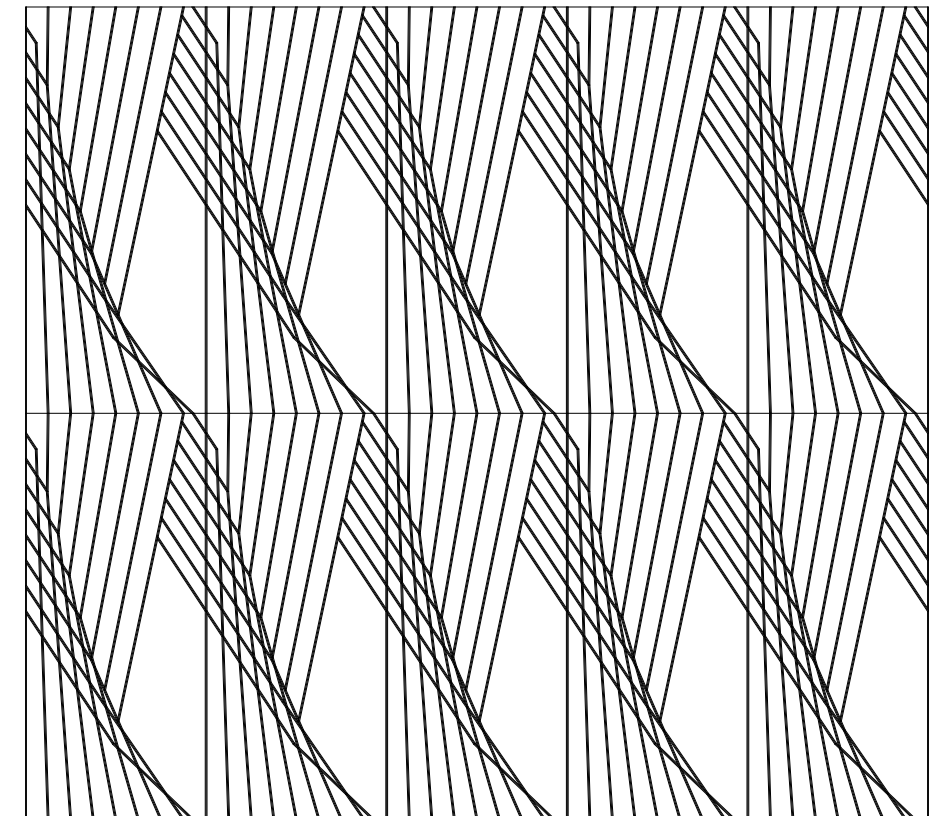

Prism Pattern

Recommended Layout

Prism

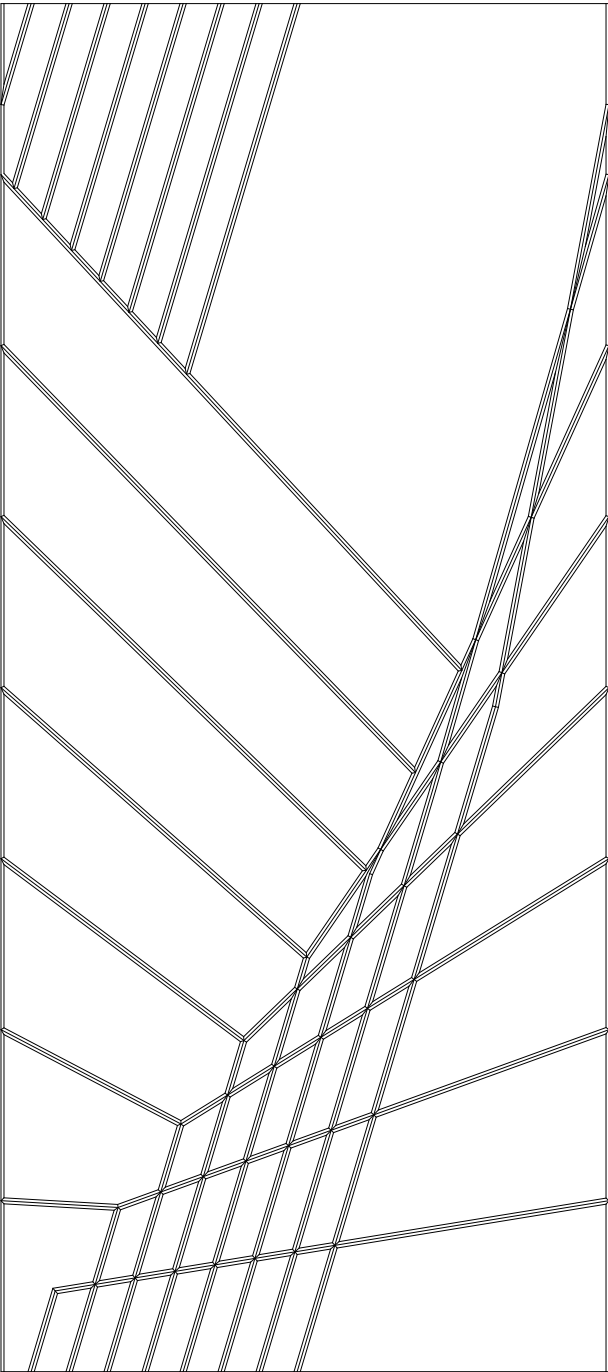

Layout 1

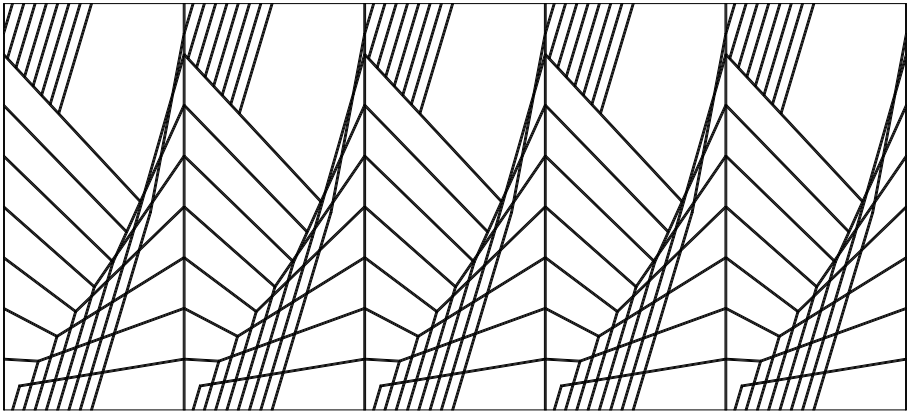

Layout 2

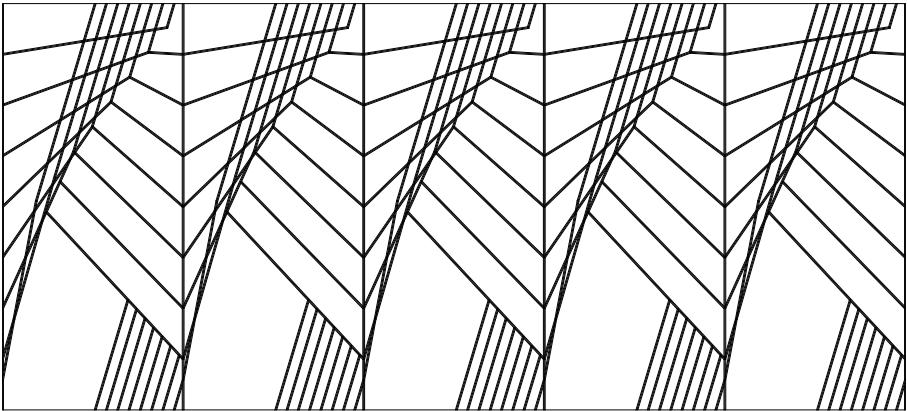

Layout 3

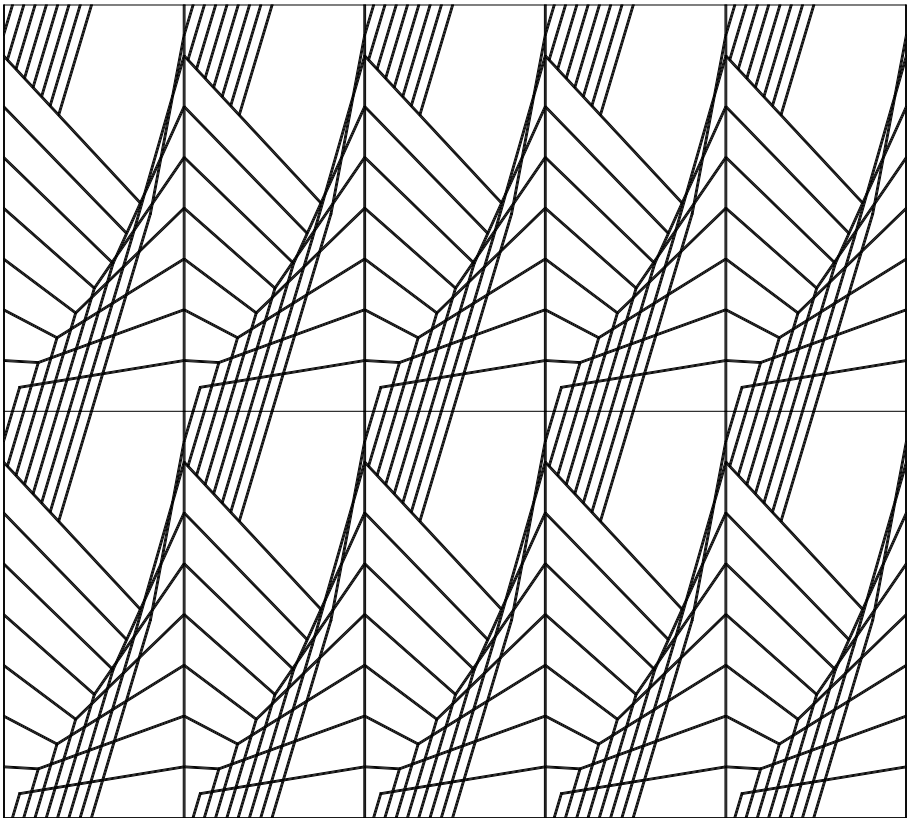

Layout 4

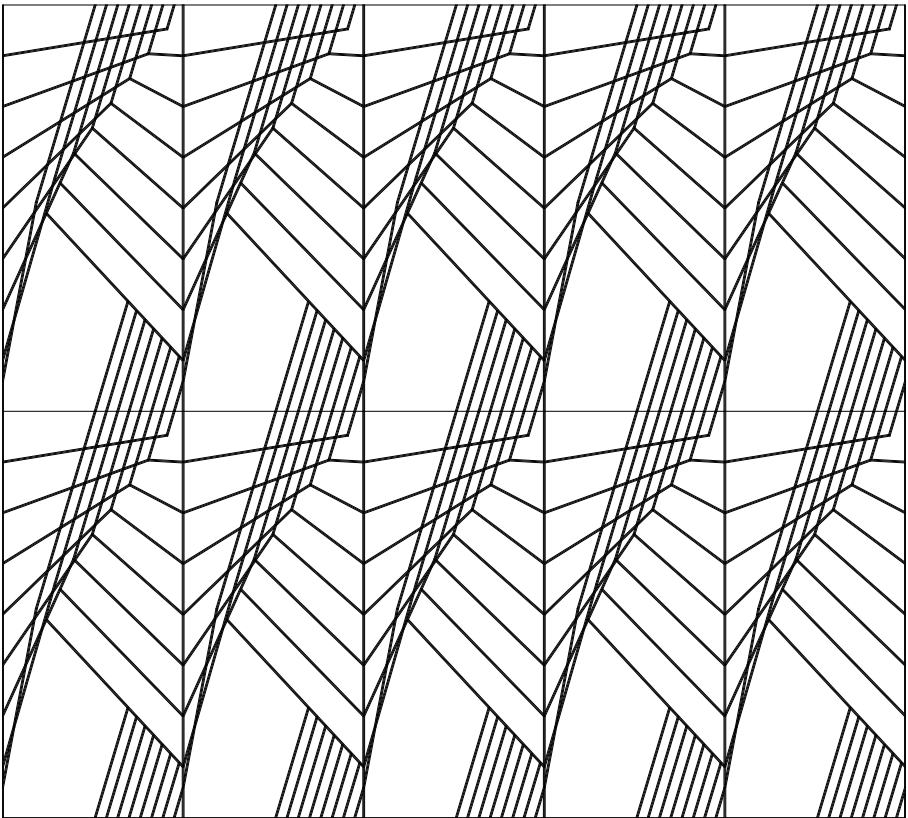

Rowhouse Pattern

Recommended Layout

Rowhouse

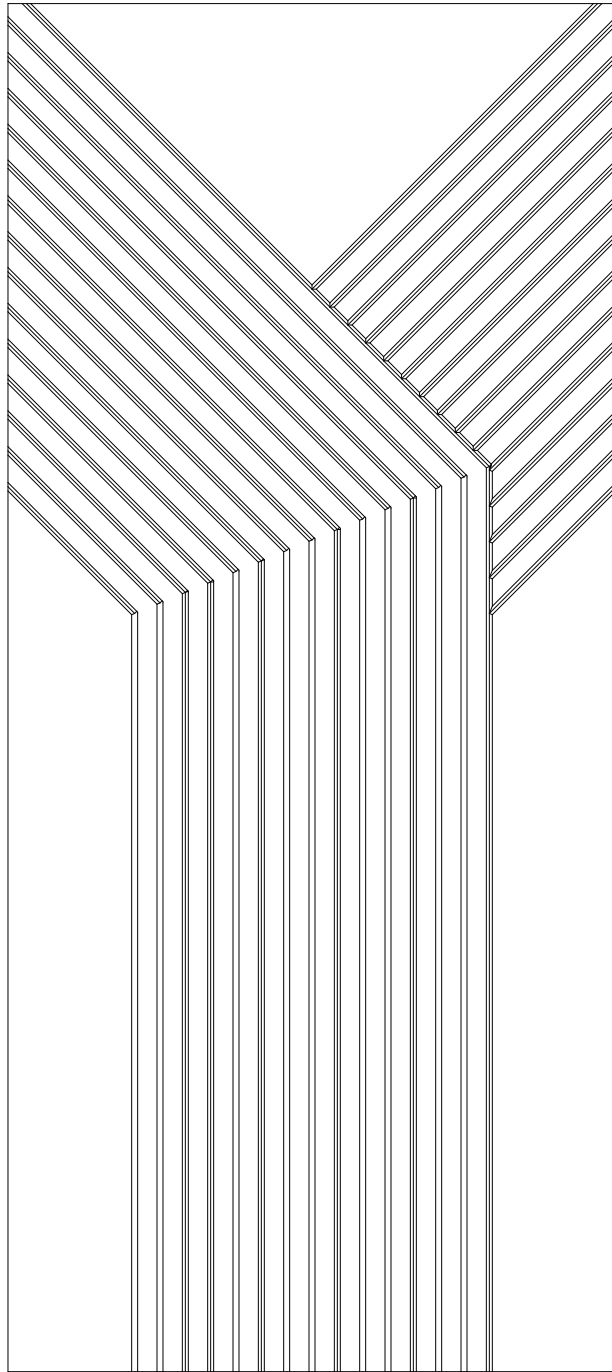

Layout 1

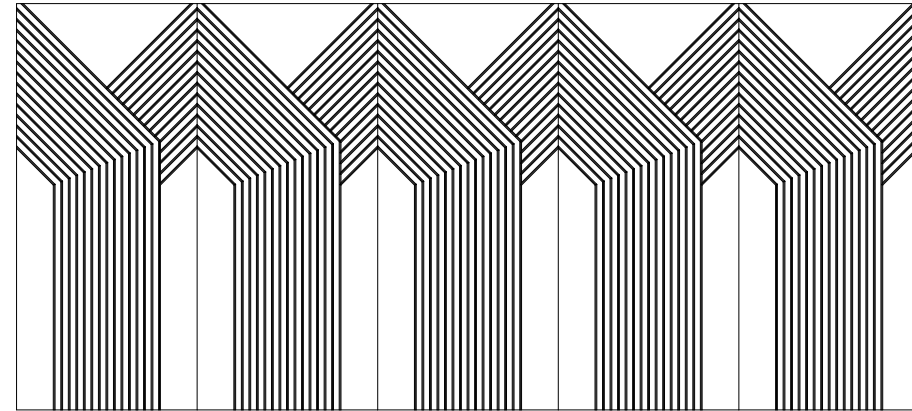

Layout 2

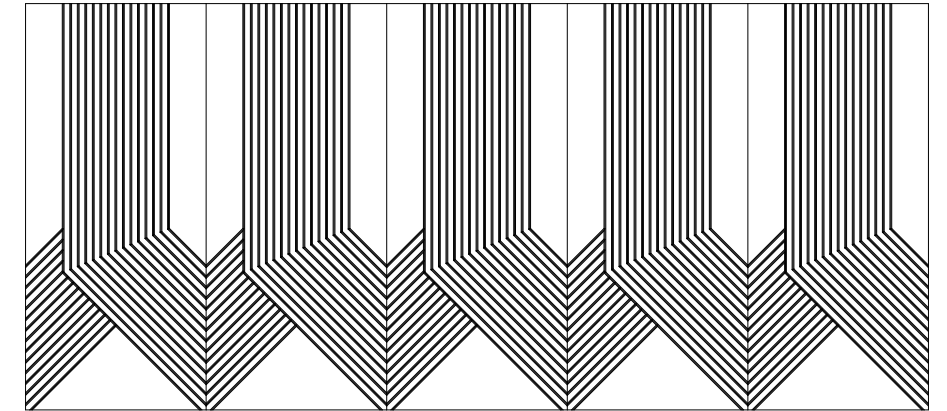

Layout 3

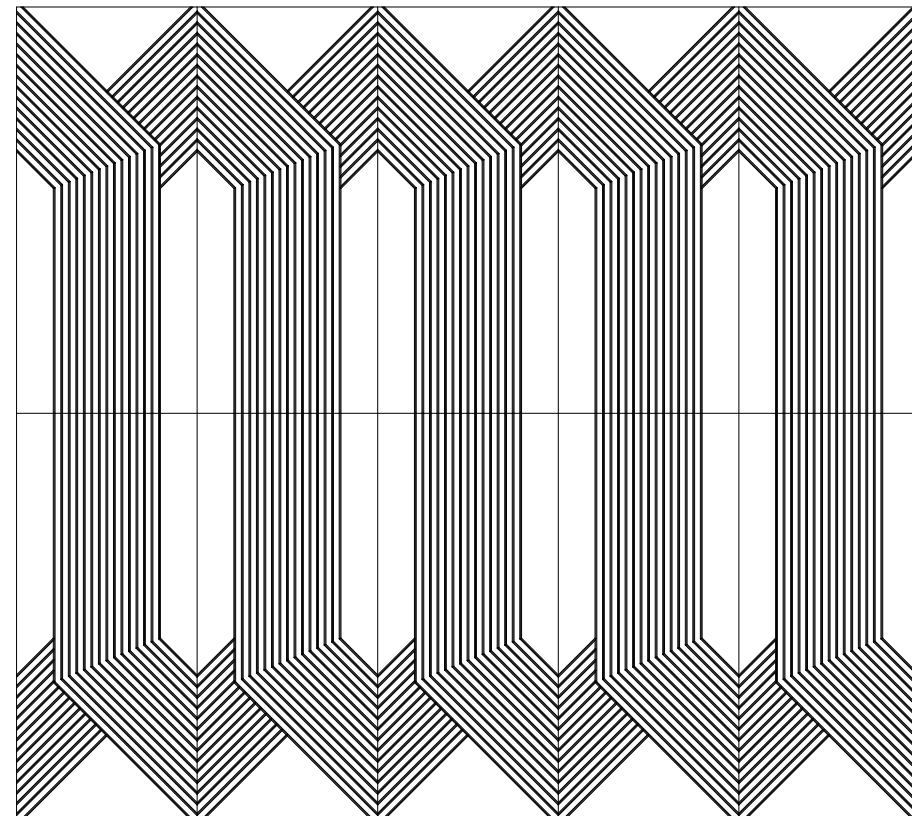

Layout 4

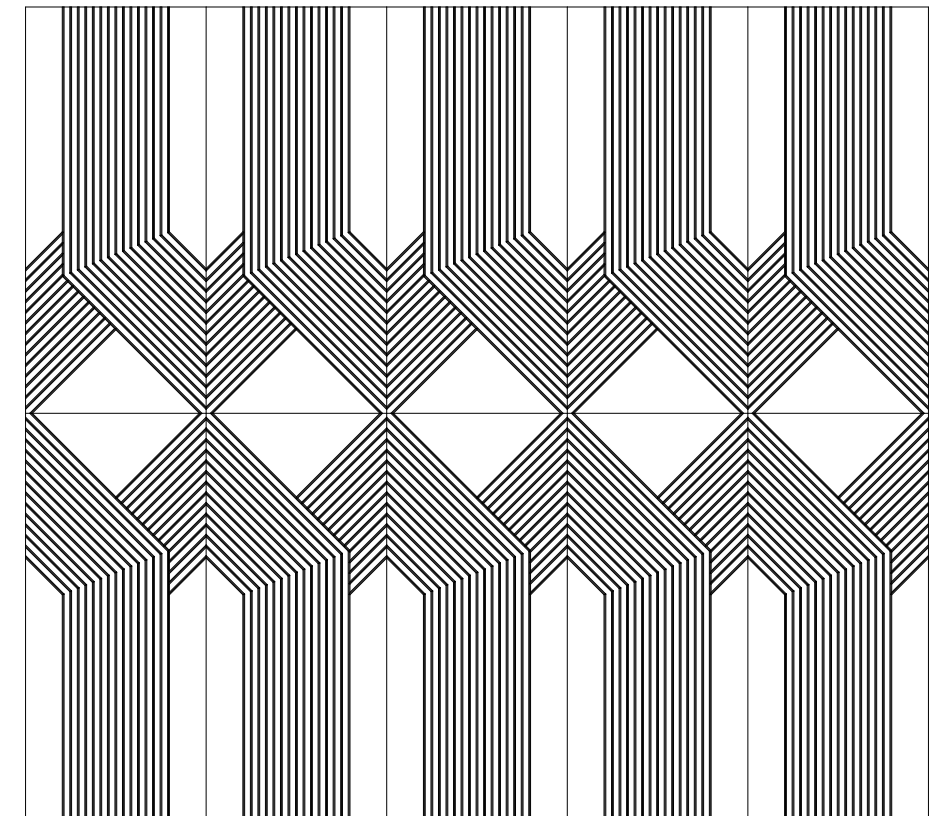

Intersect Pattern

Recommended Layout

Intersect

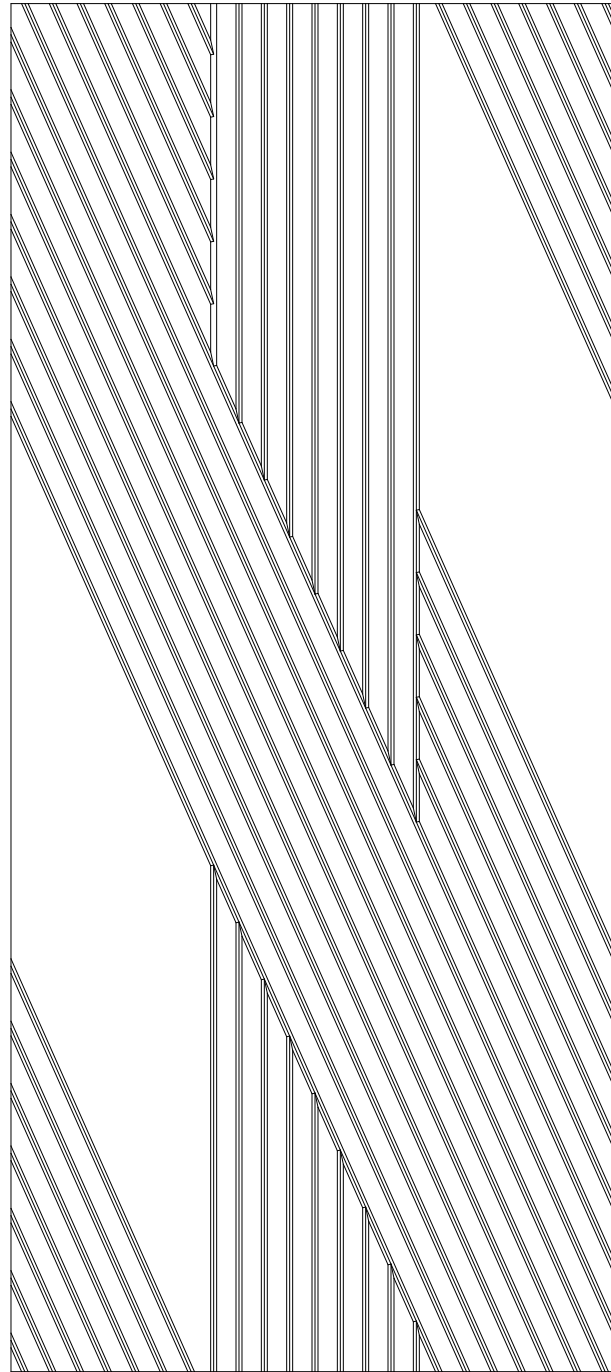

Layout 1

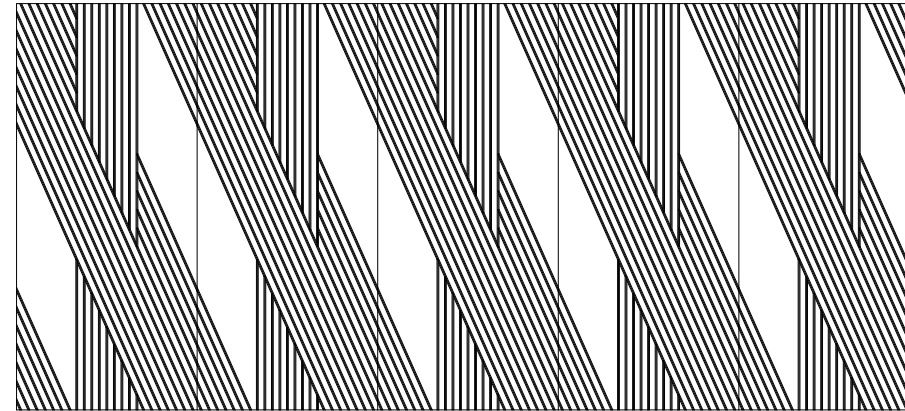

Layout 2

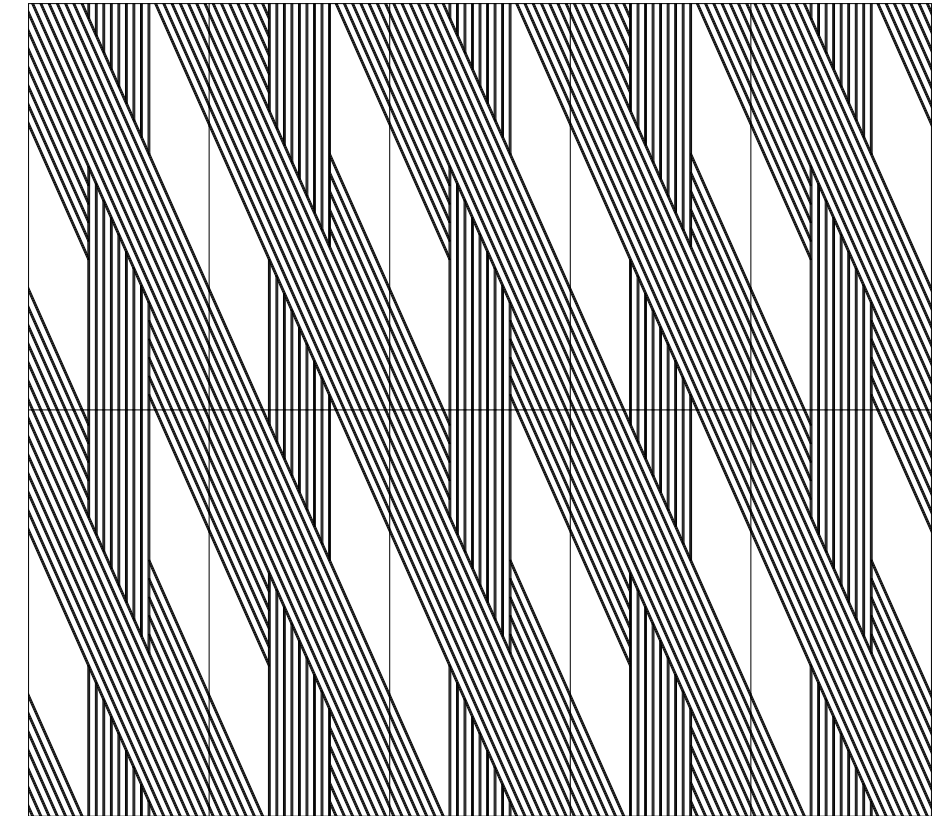

Knit Pattern

Recommended Layout

Knit

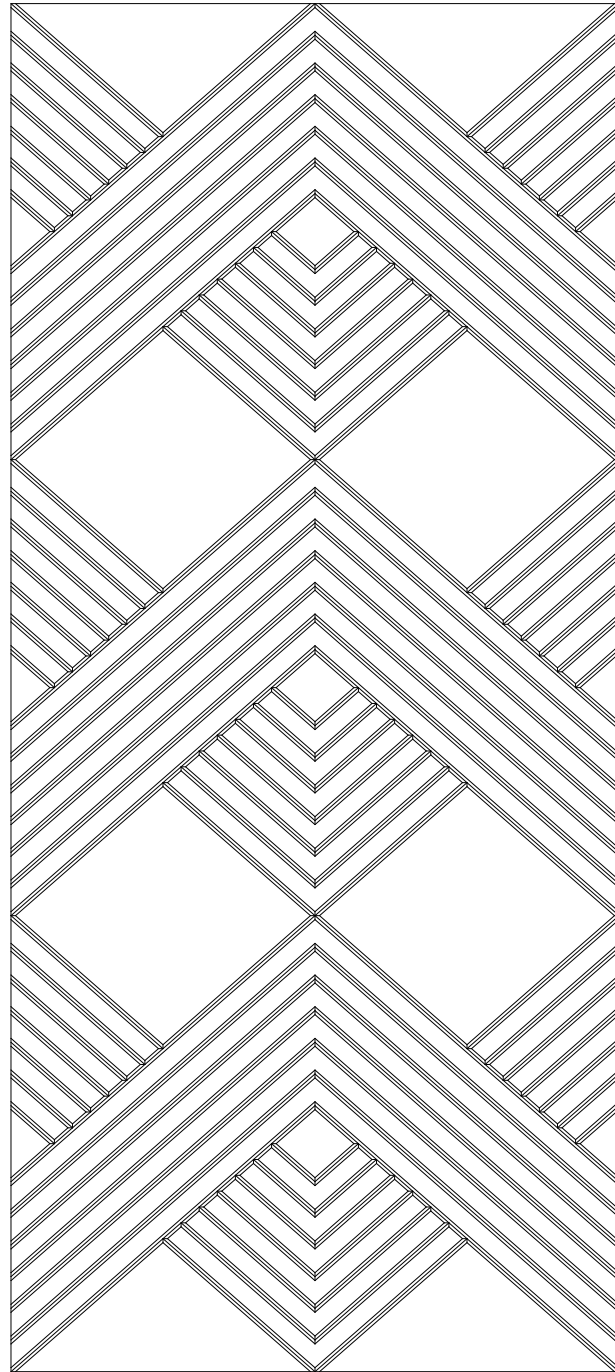

Layout 1

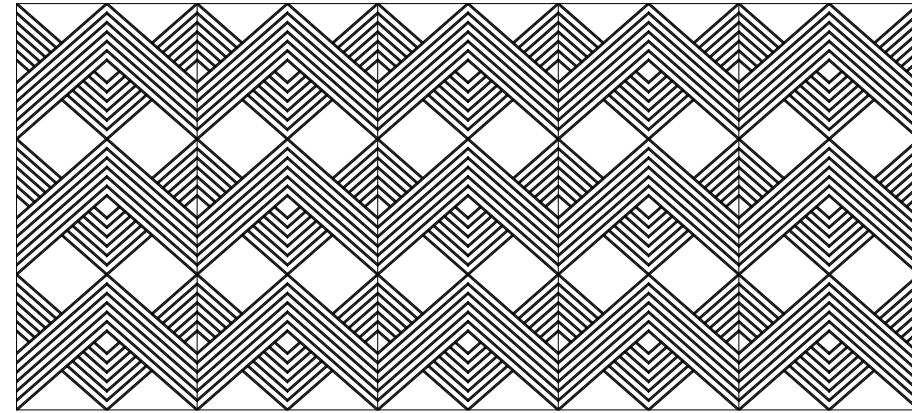

Layout 2

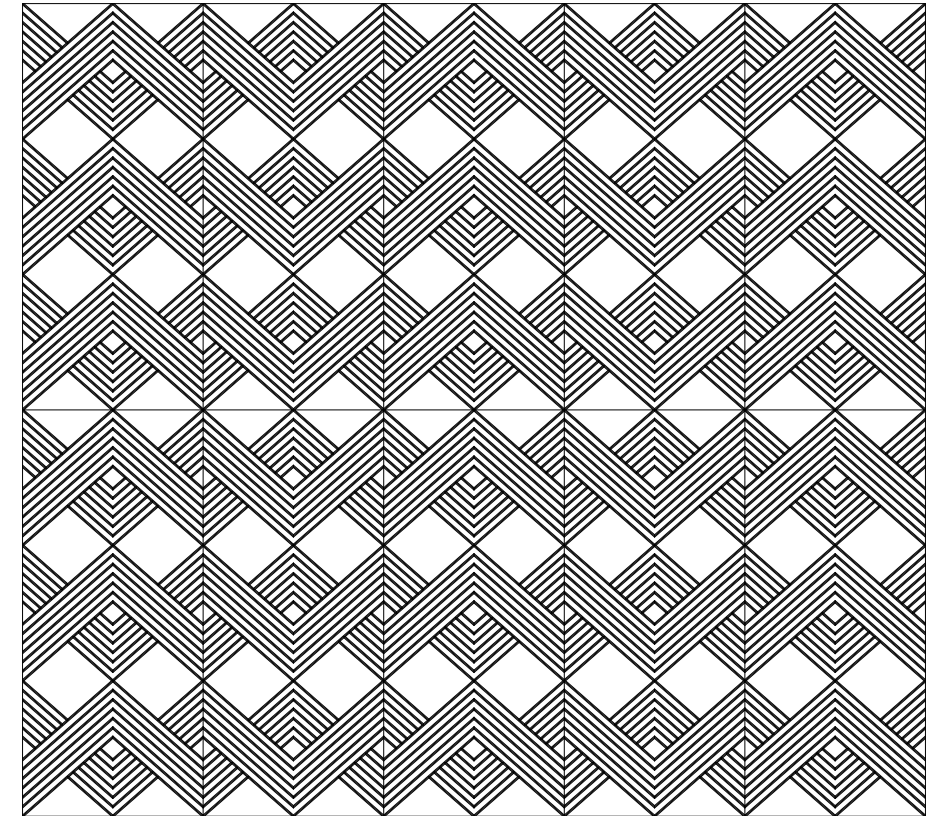

Lattice Pattern

Recommended Layout

Lattice

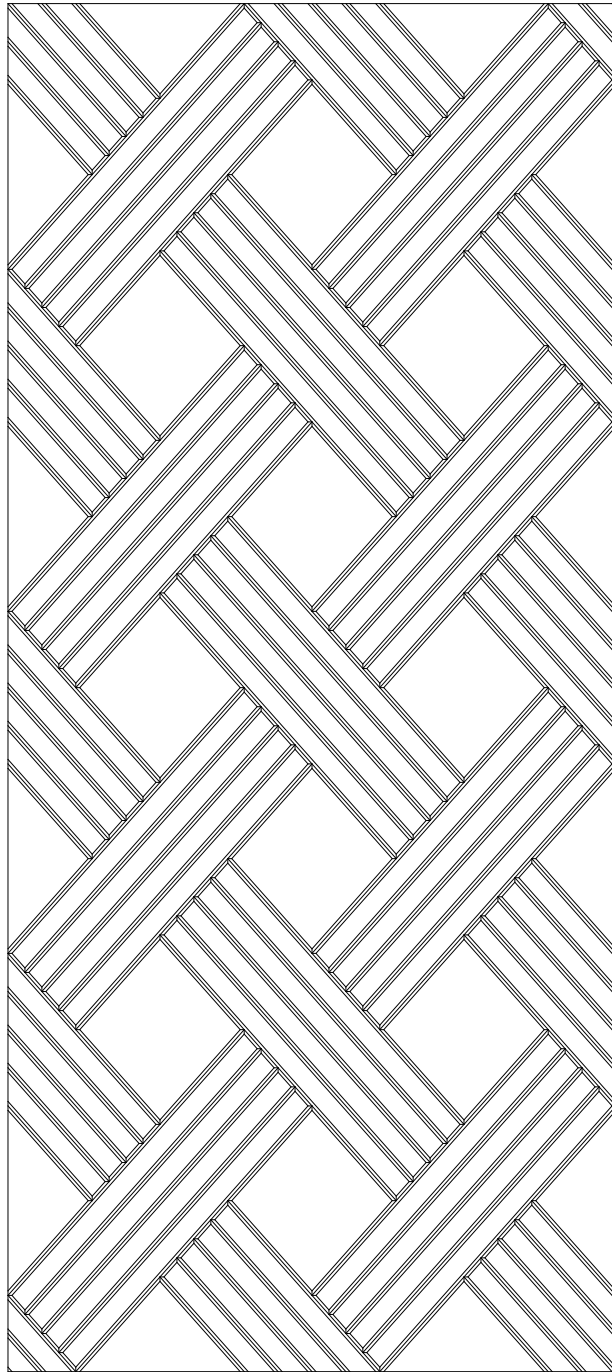

Layout 1

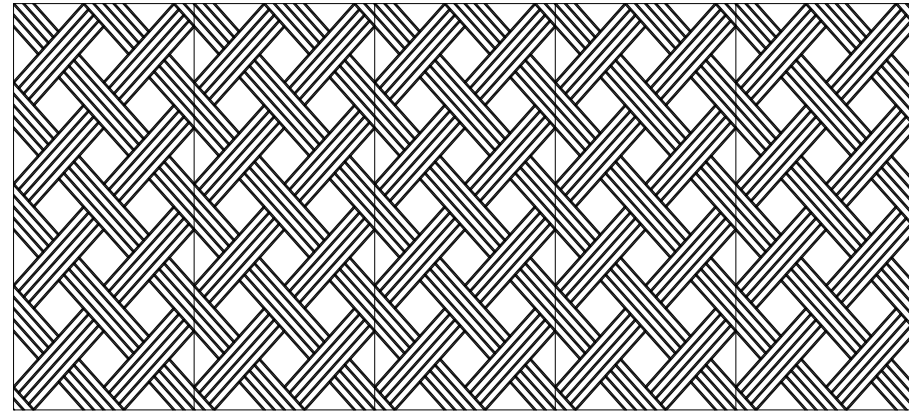

Layout 2

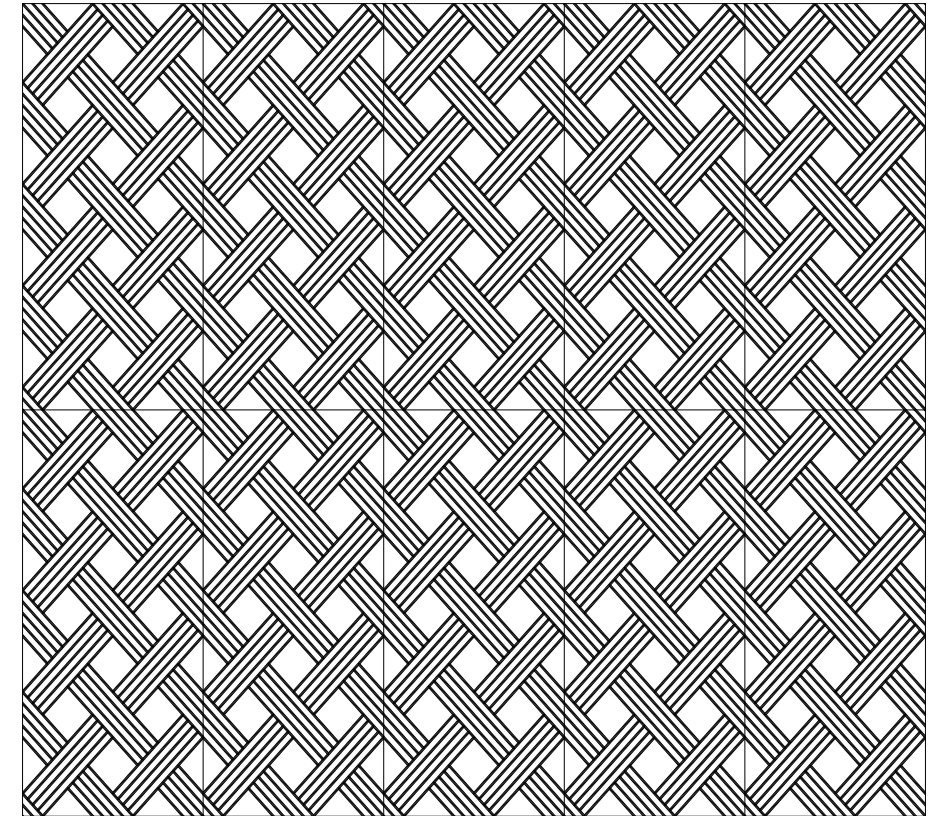

Maze Pattern

Recommended Layout

Maze

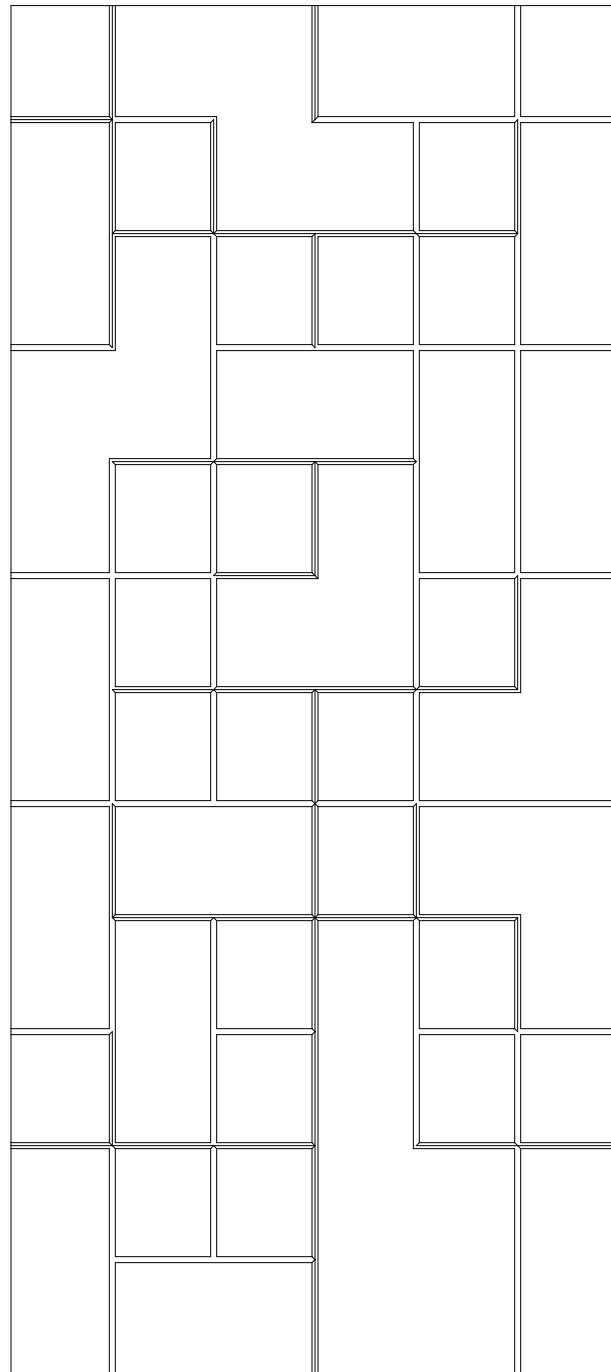

Layout 1

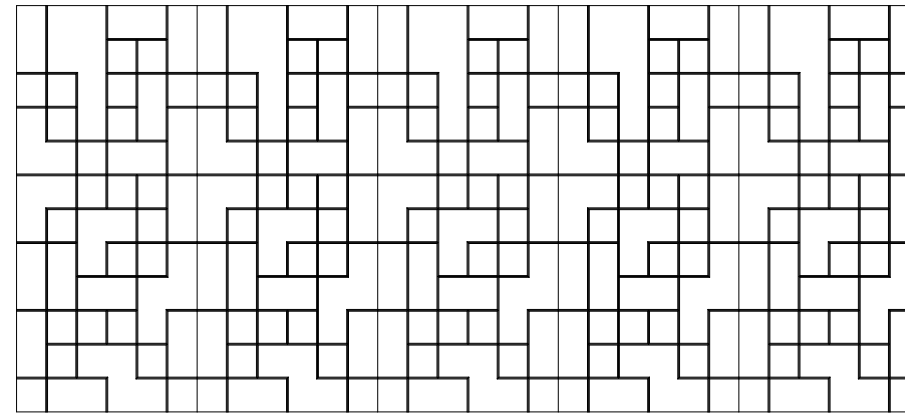

Layout 2

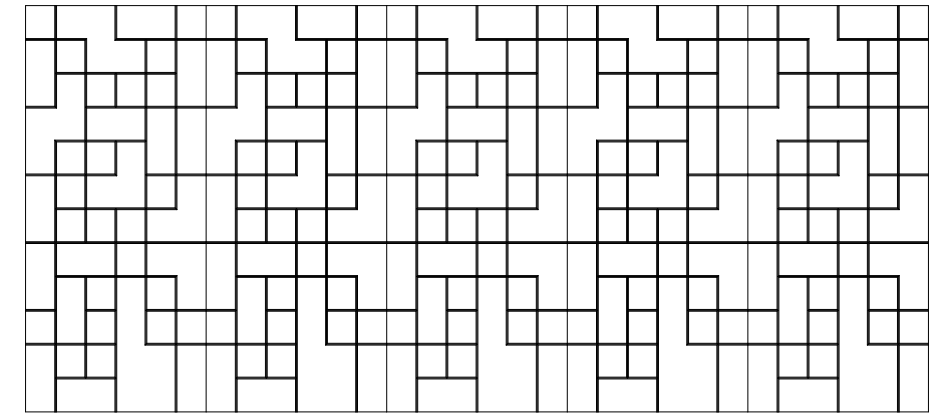

Layout 3

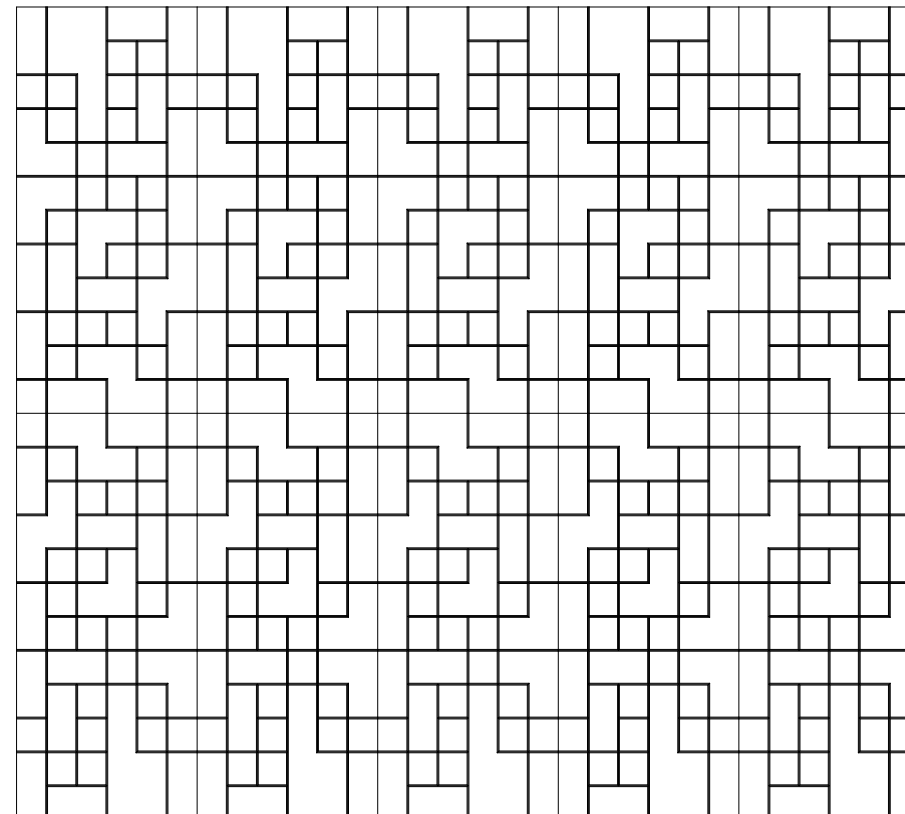

Layout 4

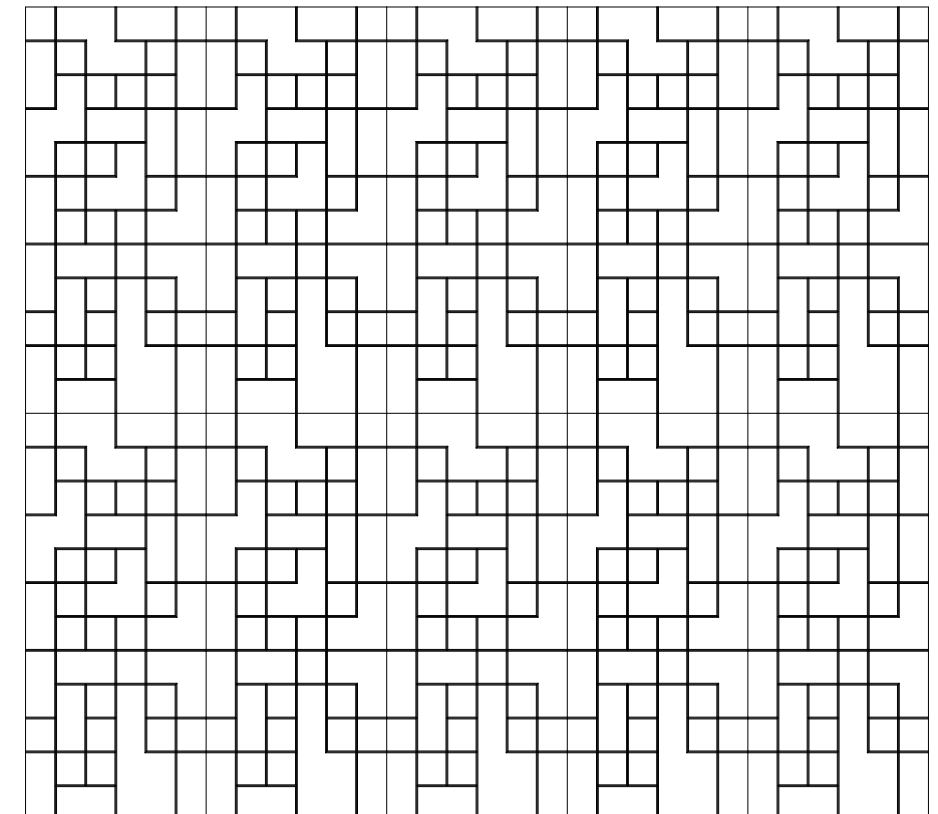

Formula Pattern

Recommended Layout

Formula

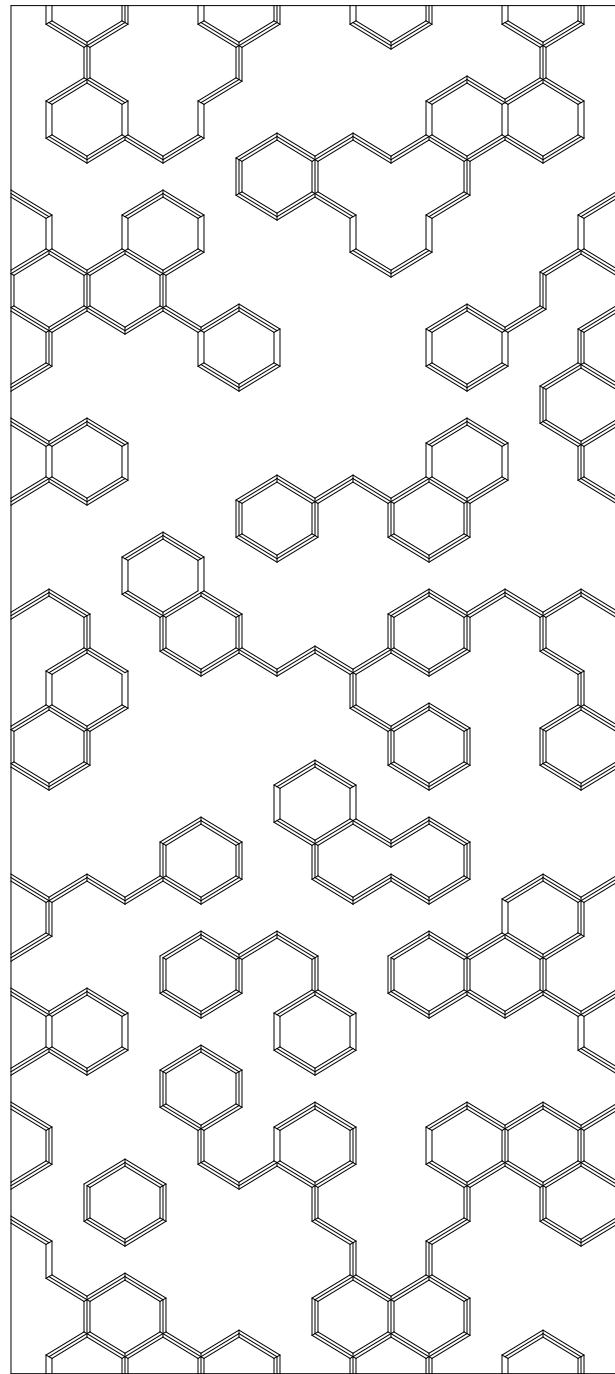

Layout 1

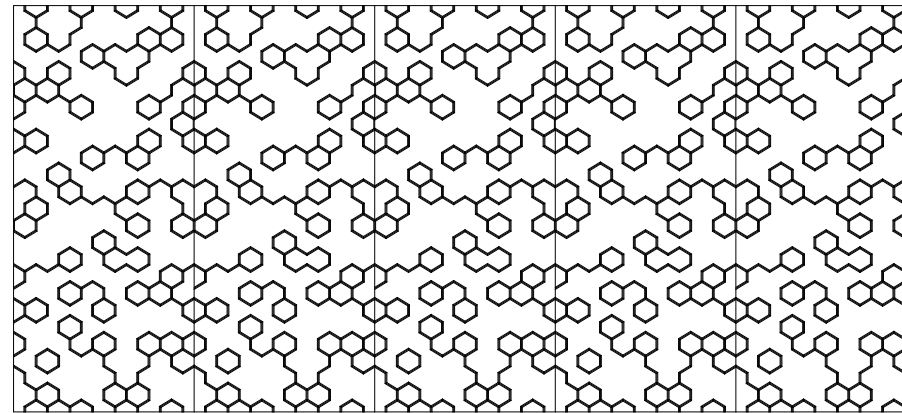

Layout 2

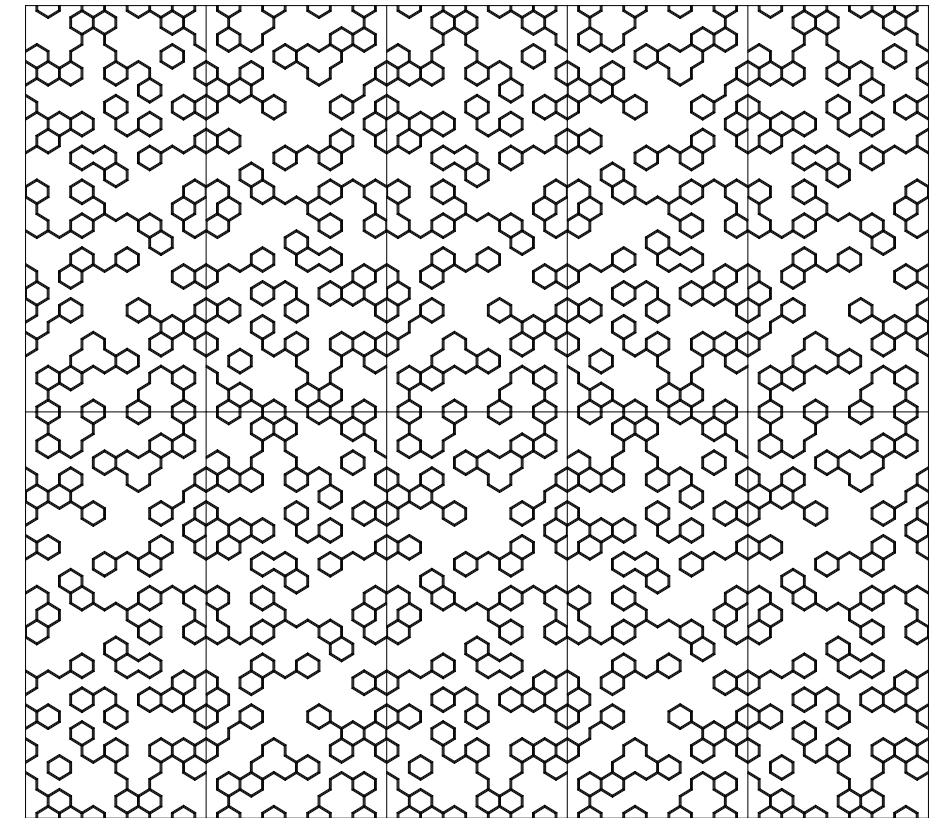

Fineline Pattern

Recommended Layout

Fineline

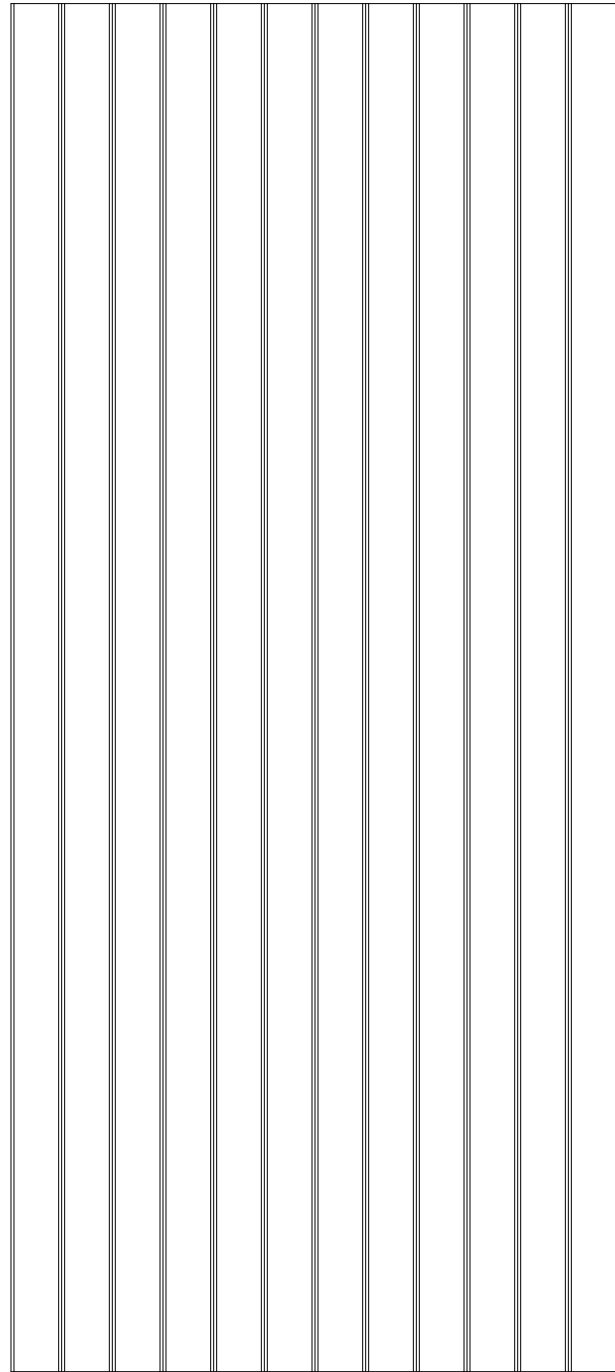

Layout 1

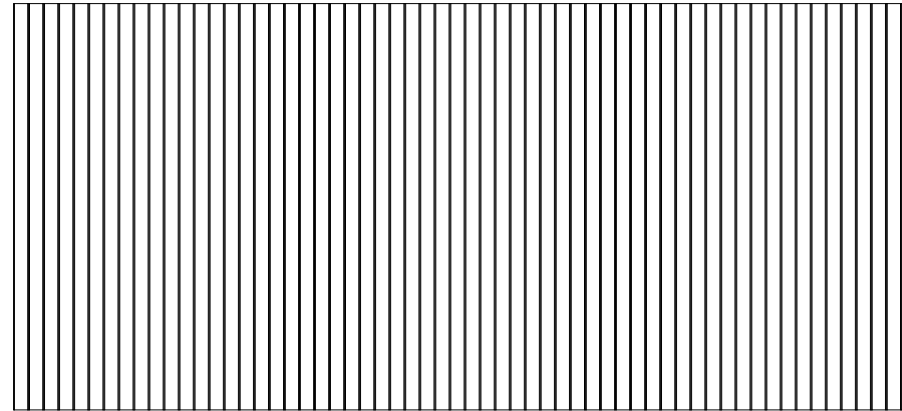

Layout 2

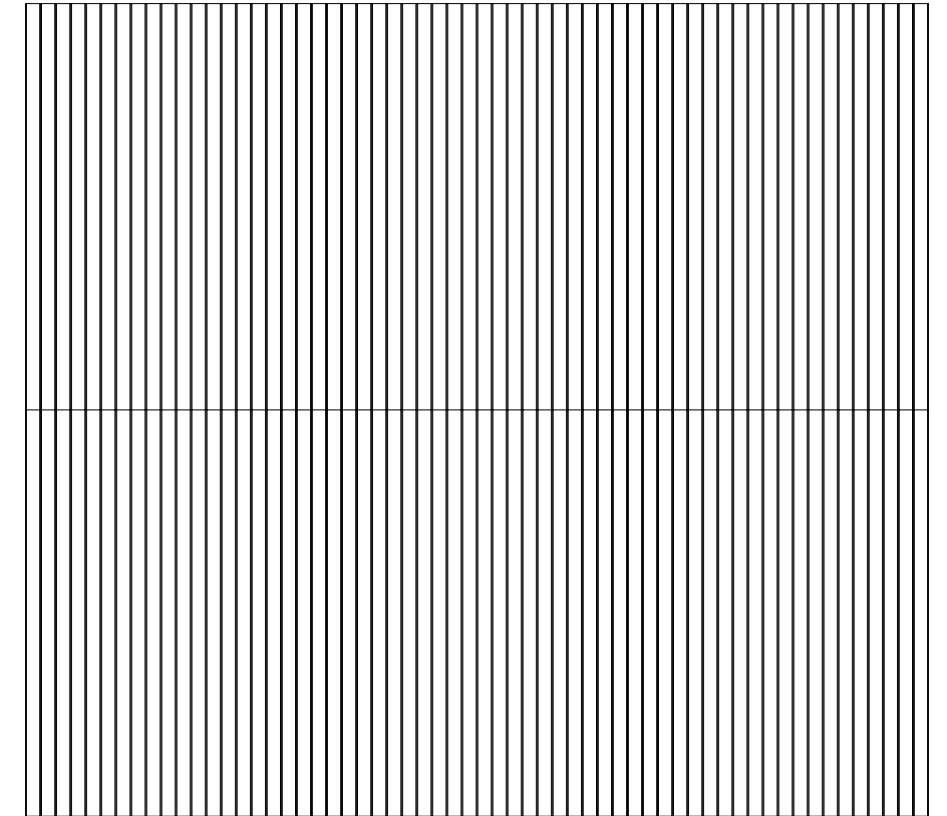

Diagonal Pattern

Recommended Layout

Diagonal

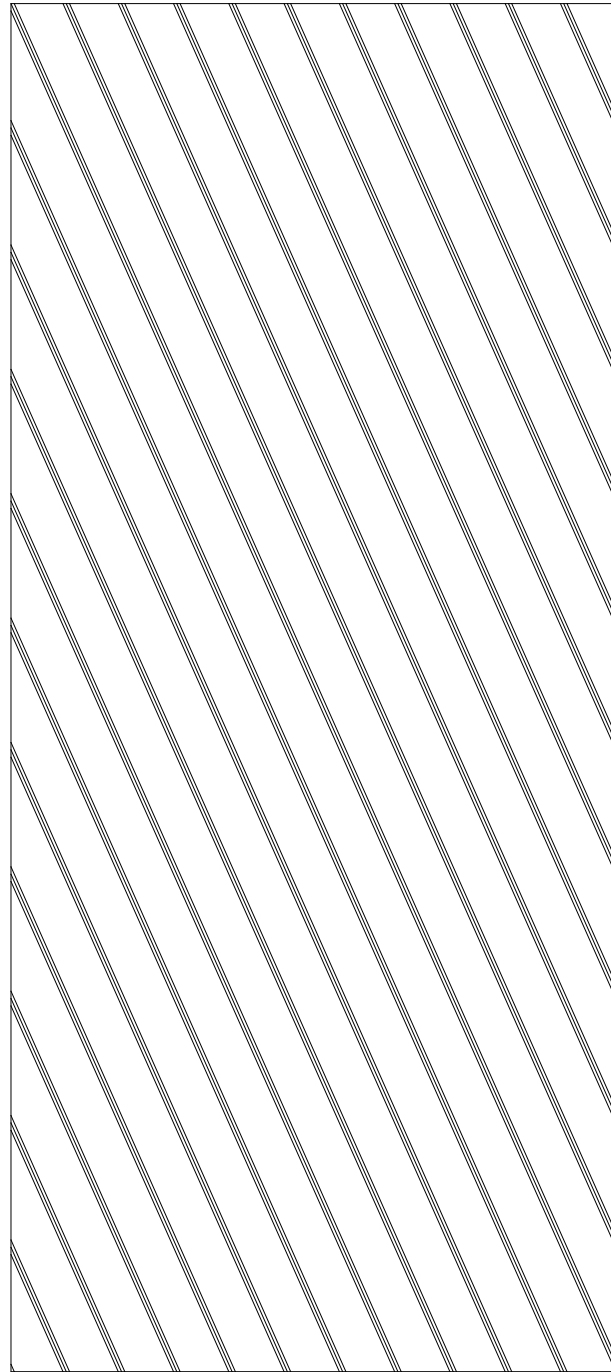

Layout 1

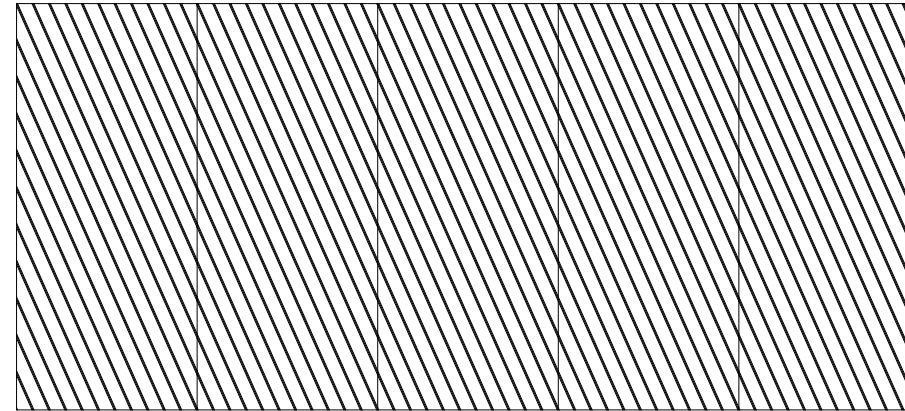

Layout 2

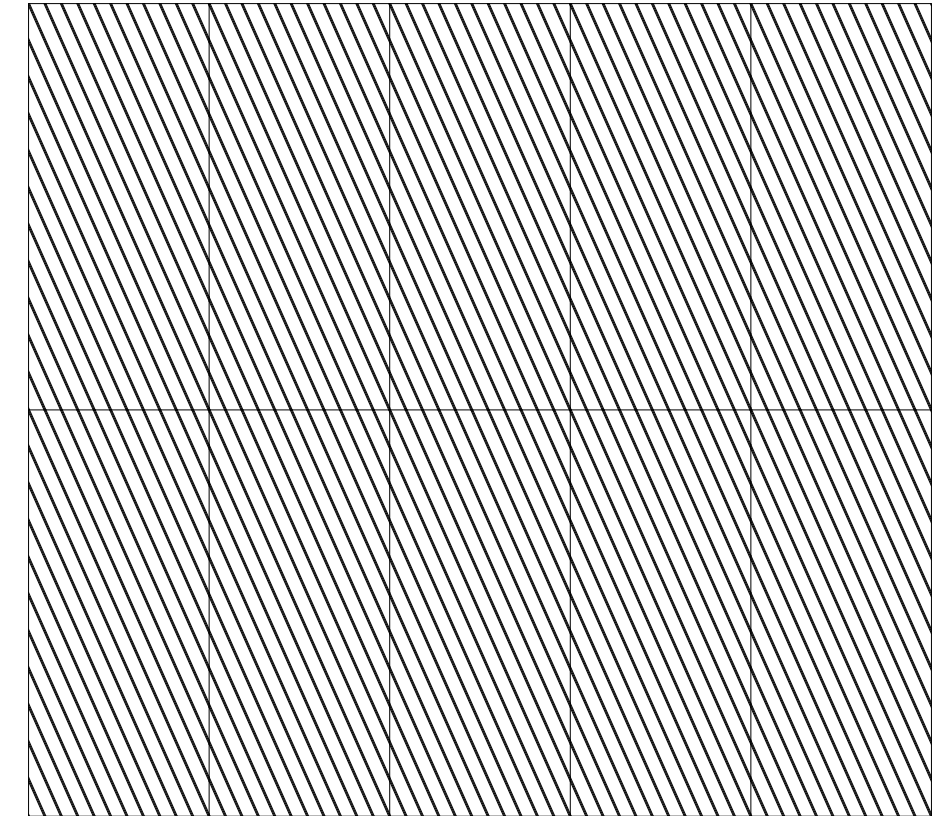

Trellis Pattern

Recommended Layout

Trellis

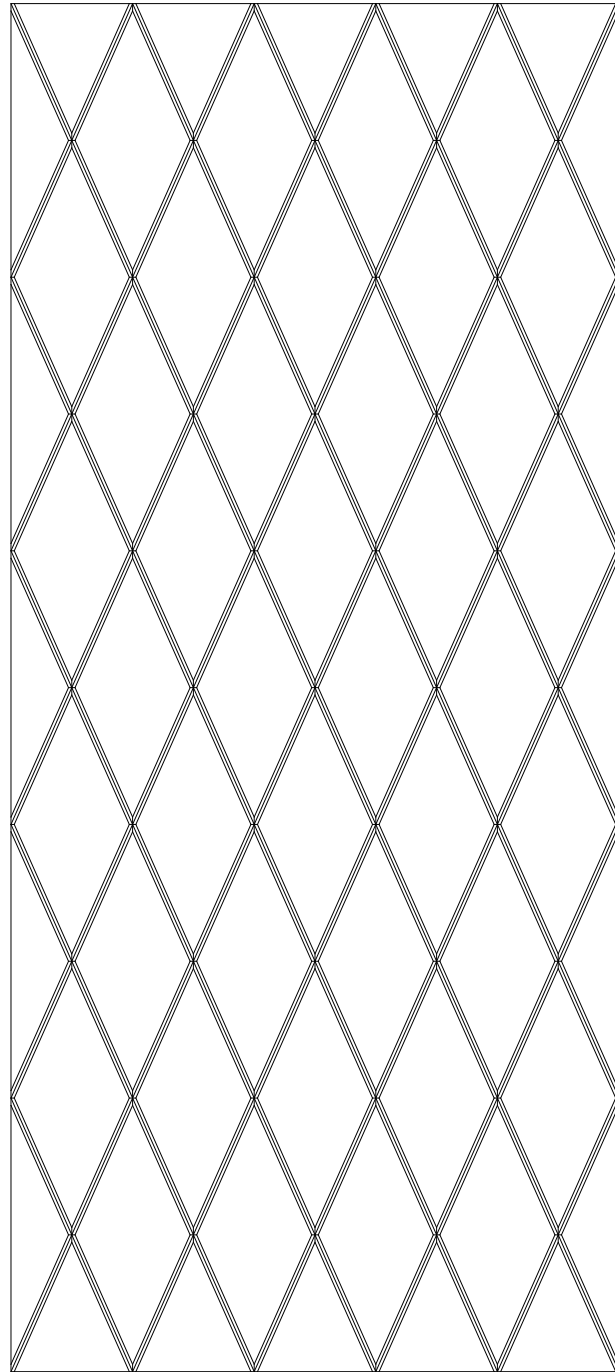

Layout 1

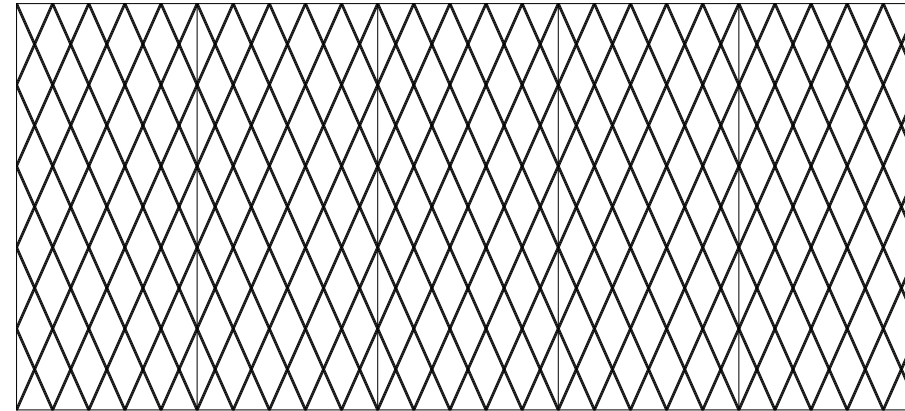

Layout 2

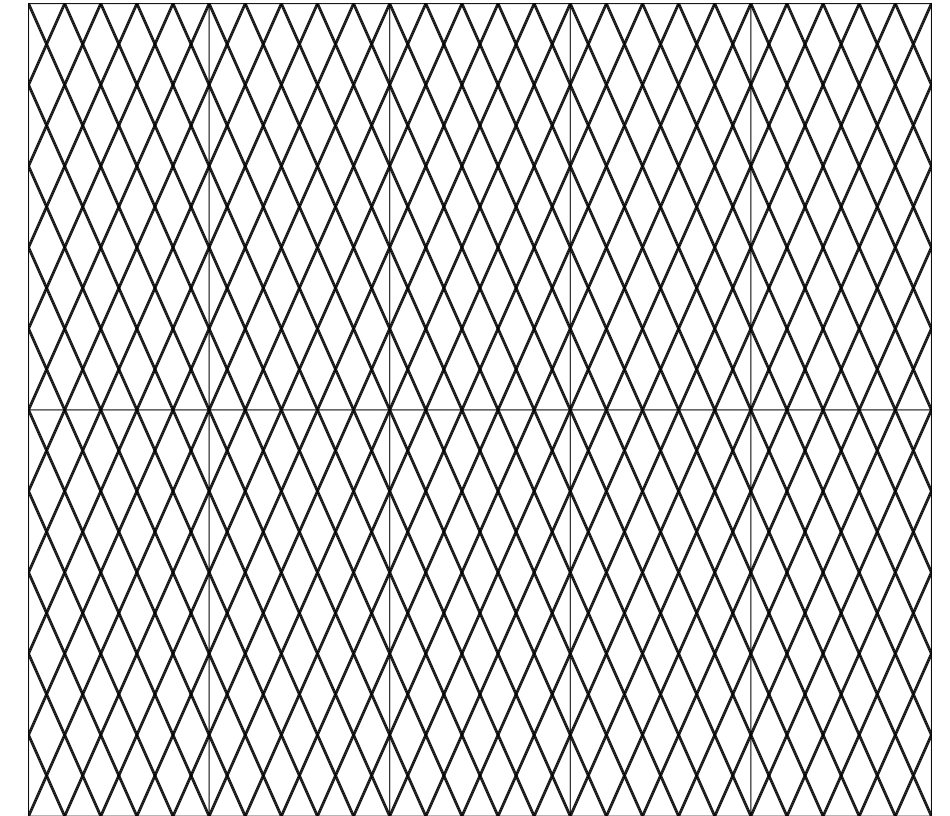

Wavelength Pattern

Recommended Layout

Wavelength

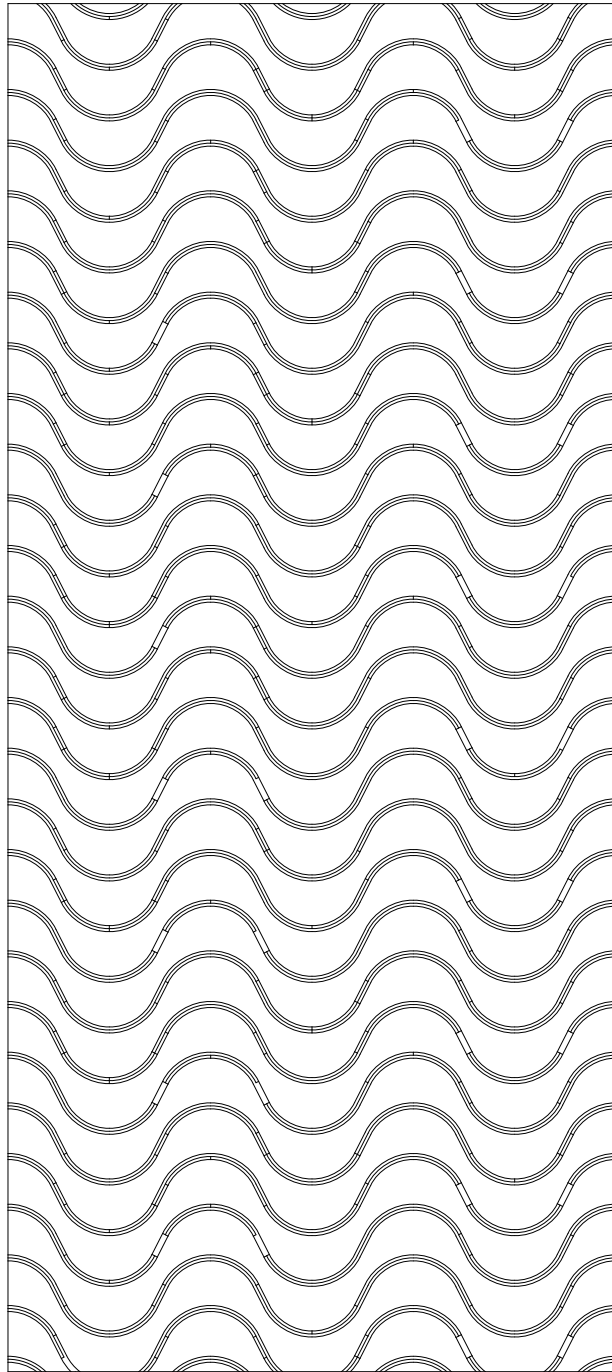

Layout 1

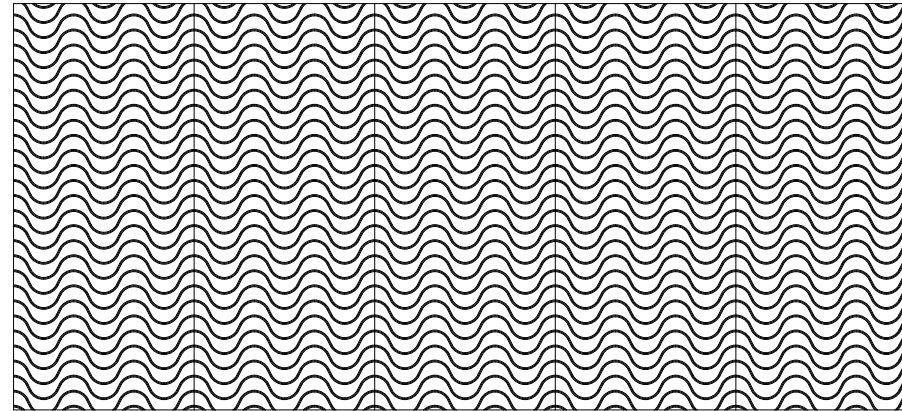

Layout 2

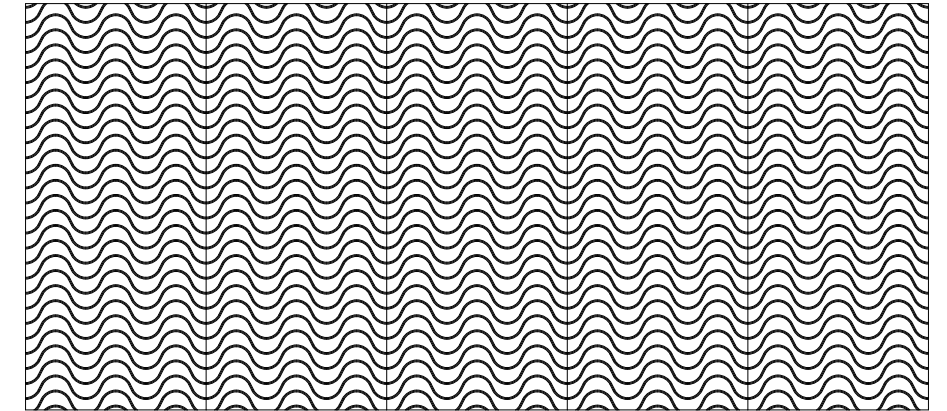

Layout 3

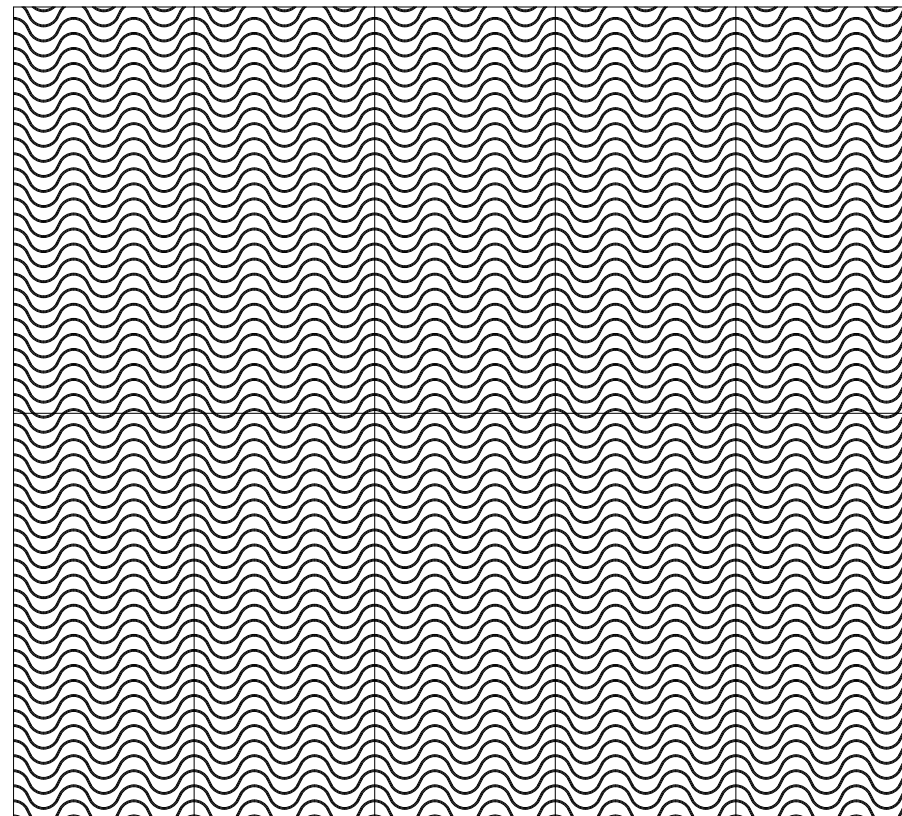

Layout 4

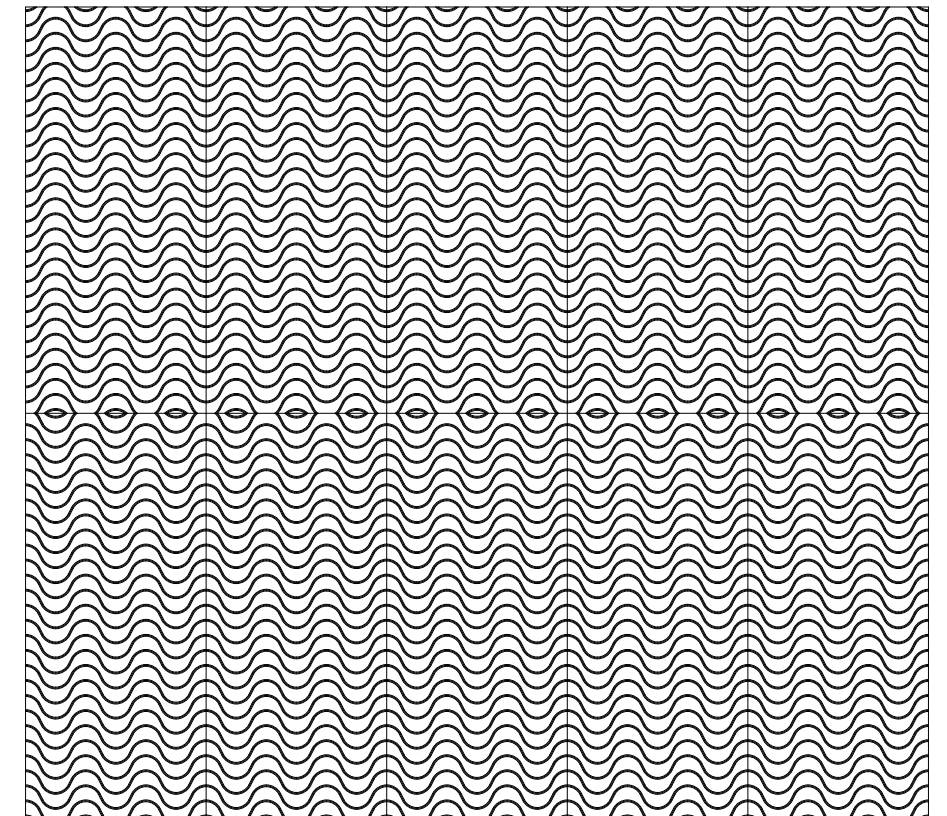

Mounting Methods

Construction Adhesive

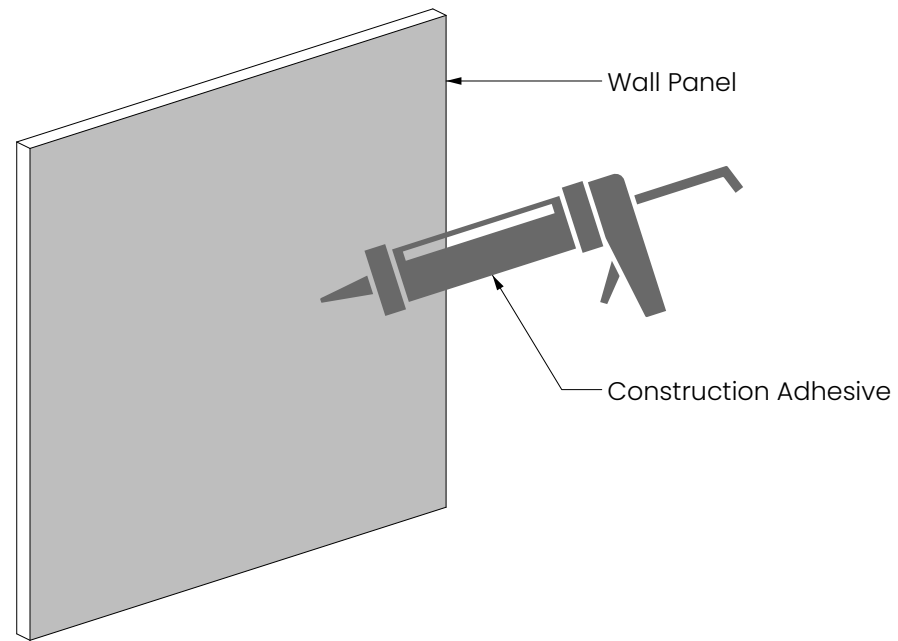

Z-Clip Mount

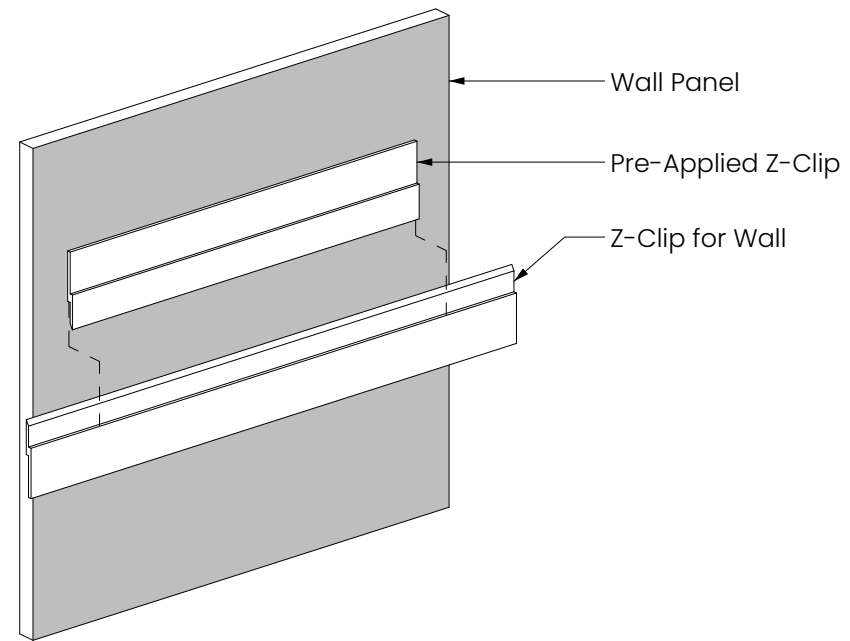

Colorways



Peppercorn

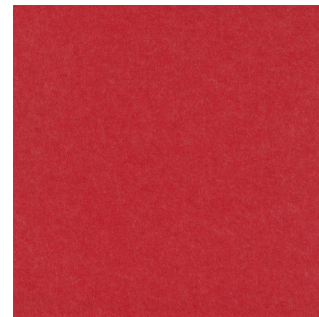

Lipstick Red

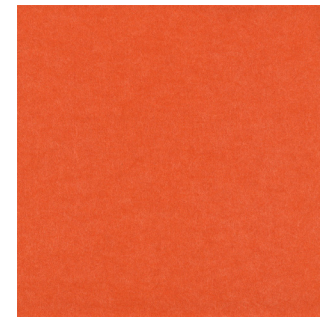

Carrot

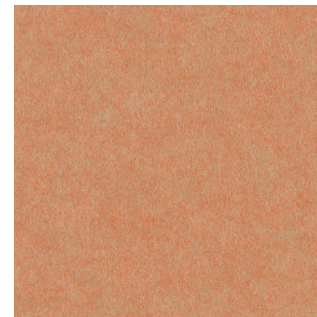

Peach

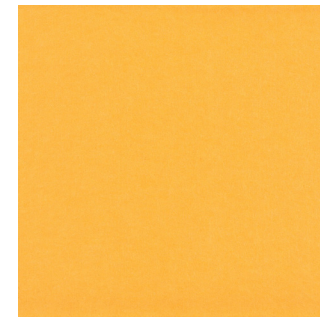

Butter

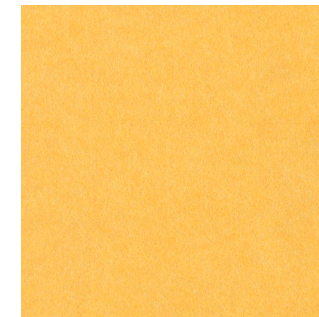

Popcorn

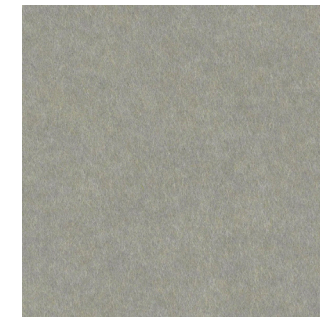

Pistachio

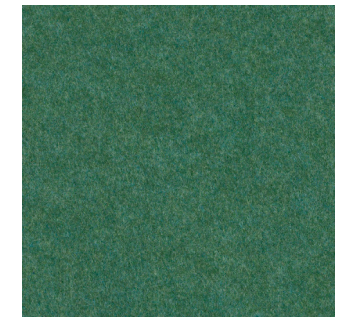

Thistle



Oregano

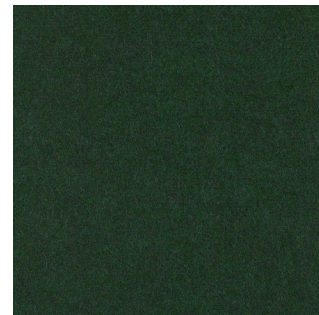

Kale



Wasabi

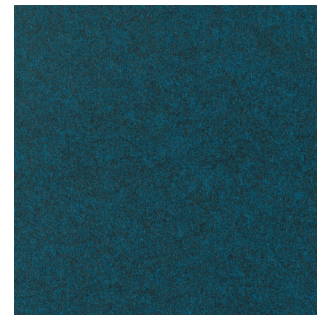

Denim



Peacock

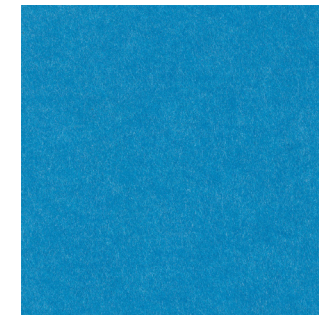

Azur

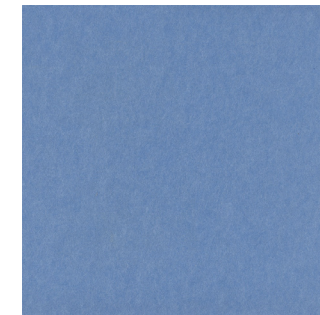

Marine

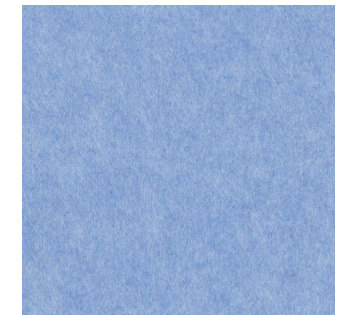

Periwinkle



Lilac



Iris



Berry

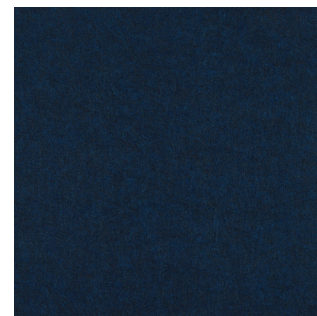

Midnight

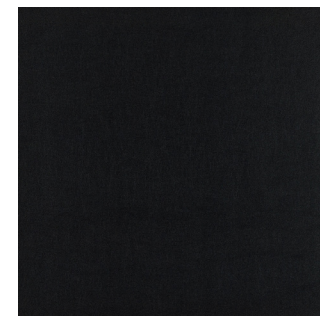

Piano Black



Charcoal

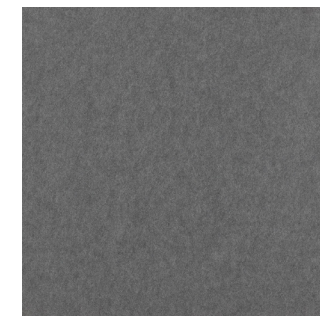

Slate



Grey

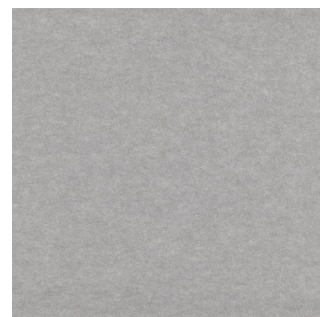

Metal



Platinum

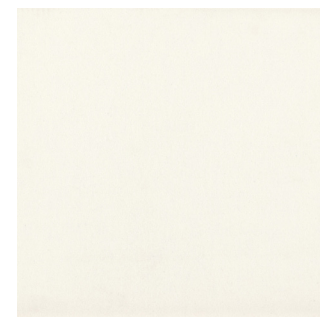

White



Ivory

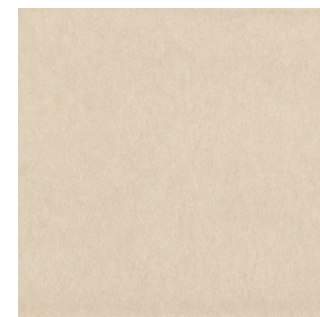

Pearl