

Coffered Direct Fix Tile

—
An understated acoustic tile for walls + ceilings available
in a range of sizes, colours + prints

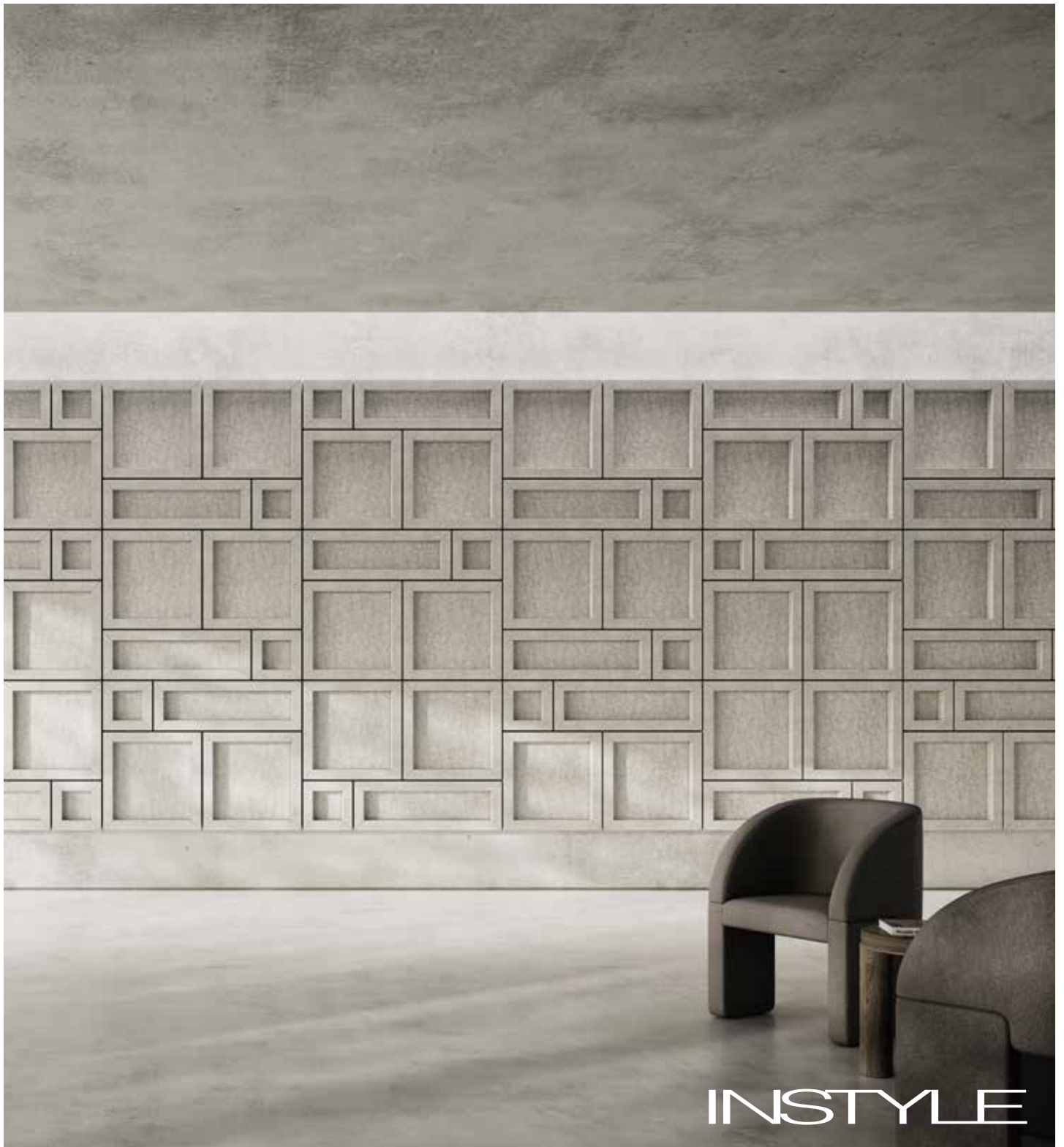



PRODUCT	Ecoustic® Coffered Direct Fix Tile
DESCRIPTION	Ecoustic® Coffered is a high-performance acoustic tile direct fixed to wall or ceiling surfaces, available in two depths, 50 + 100, three tile sizes and a wide range of colours + prints
DIMENSIONS	3x3 Tile: 300mm (w) x 300mm (h) 6x6 Tile: 600mm (w) x 600mm (h) 9x3 Tile: 900mm (w) x 300mm (h) Depths: 50mm (d) or 100mm (d)
COMPOSITION	100% PET
ACOUSTIC	NRC 1.0 / α_w 1.0 / SAA 0.99^ ^Ceiling Grid Test Coffered Deep 345mm void Refer to acoustic results on next page
FIRE TEST AS/ISO 9705	Group 1 SMOGRA <100 NZBC Group 1-S
ASTM E84	12mm: Class A
APPLICATION	Wall or ceiling tiles
ORIGIN	Designed + made in Australia
WARRANTY	A 12 month warranty is provided against manufacturing defects. This applies to internal installation only, outdoor use will void any warranty

Please contact your representative for CAD drawings

Designed for the Environment



Building Rating Systems: Coffered Direct Fix will contribute the following points for Green Star, LEED + WELL building standards.

Criteria	Green Star	LEED	WELL
Low VOC	✓	✓	✓
Stewardship - Recycling	✓	✓	NA
Cradle to Cradle Certification	NA	✓	✓
Declare Label	NA	✓	✓
Manufacturer EMS	✓	NA	NA
Toxic Material Reduction	NA	NA	✓

HOW TO SPECIFY

DESIGN	Ecoustic® Coffered Direct Fix
TILE SIZE	3x3 Tile, 6x6 Tile, 9x3 Tile
DEPTH	50mm or 100mm nominal
COLOUR - FRAME	Select from: Ecoustic® SC Panel 12mm colours Ecoustic® Timbre print Ecoustic® Timbre Point print
COLOUR - BACK	Select from: Ecoustic® SC Panel 12mm colours Ecoustic® Timbre print Ecoustic® Timbre Point print Frame and Back components may be specified in different colourways

Front View

COFFERED DIRECT FIX 3x3

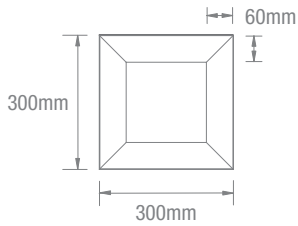

COFFERED DIRECT FIX 6x6

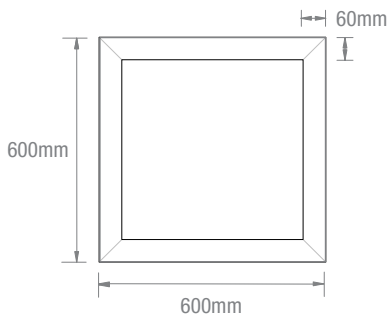

COFFERED DIRECT FIX 9x3



Side View

COFFERED DIRECT FIX 3x3-100

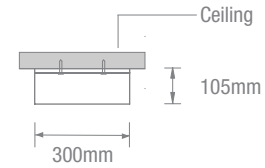

COFFERED DIRECT FIX 3x3-50

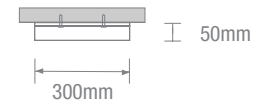

COFFERED DIRECT FIX 6x6-100

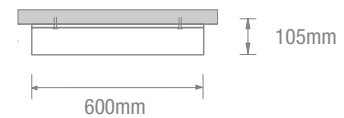

COFFERED DIRECT FIX 6x6-50

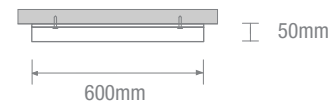

COFFERED DIRECT FIX 9x3-100

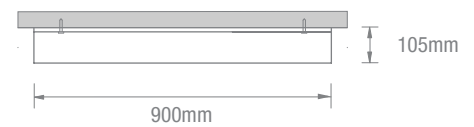

COFFERED DIRECT FIX 9x3-50

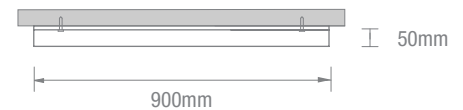

IMPORTANT

Moisture Absorption: After four days at 50°C, 95% RH the moisture absorbency of SC 12mm was less than 0.3% by weight. As Ecoustic® Coffered Direct Fix is 100% polyester, it will not degrade over time due to moisture, mildew or rot in office environments.

Fixtures: Any fixture must be supported independent to the Ecoustic® Coffered Direct Fix tile. The tiles can be cut on site to accommodate for new and existing lighting and fixtures. When cutting use a new blade for each cut and ensure the area to be cut is fully supported. Cut the tile face with care.

Back Loading: Ecoustic® Coffered Direct Fix is not suitable for back loading. Fixture loads must be supported independently from the tile.

Toxicity: Polyester is non-toxic and is classed the same as wood under the State of New York Article 15 Part 1120. Ecoustic® Coffered Direct Fix does not contain any Red List Chemicals (USA EPA).

Ecoustic® Coffered Tile

NRC 1.0 / α_w 1.0 / SAA 0.99^

^Ceiling Grid Test Coffered Deep 345mm void

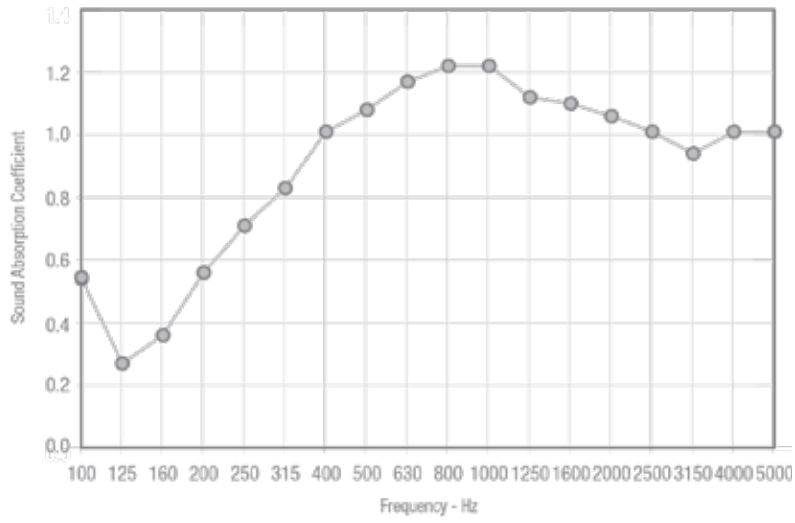

Frequency	Sound Absorption Coefficient
100	0.54
125	0.49
160	0.61
200	0.78
250	0.88
315	0.92
400	0.96
500	1.00
630	1.06
800	1.08
1000	1.05
1250	1.03
1600	1.03
2000	1.02
2500	1.05
3150	1.02
4000	1.06
5000	1.08
NRC	1.0

Coffered Direct Fix Tile Colours + Prints

Solid Colour 12mm



Snowdrop



Ecrú



Almond



Horizon



Fawn



Truffle



Venus*



Oxide



Cool

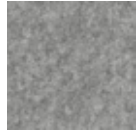

Atom



Cirrus



Tungsten



Galaxy

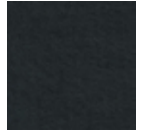

Cave



Leaf*



Olive



Isle



Azure



Bluebell*



Denim



Iris*

Timbre Print



Nordic



Maine



Rural



Heritage



Artisan



Smoked



Urban

Timbre Point Print



Nordic WD



Maine WD



Rural BD



Heritage WD



Artisan BD



Smoked BD



Urban BD

* Minimum order quantity applies

WD: White Dot

BD: Black Dot

Coffered Direct Fix Tiles with Timbre + Timbre Point are printed with leading HP low-VOC water-based latex ink technology.

Latex Print Benefits

	HP Latex Print
Non-Reactive	✓
Non-Hazardous Ink	✓
Low VOC	✓
Odourless	✓
Ink Supply Recycling	Non-hazardous ink + free take back program

- HP Latex Inks contain up to 65% water. Using water-based inks eliminates exposure to high solvent concentrations, which simplifies ventilation, storage, and transportation requirements
- **Ozone free:** No ground level ozone is generated with HP Latex Inks. Ground level ozone generation is associated with the UV ink curing process when mercury UV lamps are used.
- **No HAPs:** No Hazardous Air Pollutants (HAPs) present in HP Latex Inks. HAPs are those pollutants that are known or suspected to cause cancer or other serious health effects, such as reproductive effects or birth defects, or adverse environmental effects
- **Odourless prints:** Intensity and hedonic testing indicates weak and neutral odour for HP Latex Ink and UV ink is rated as distinct and unpleasant odour.

Ecologo Certification

A prominent, voluntary certification issued by UL and recognised worldwide. Ecologo® Certification to UL 2801 demonstrates that an ink meets a range of multi-attribute, lifecycle-based stringent criteria related to human health and environmental considerations. The standard criteria include testing for heavy metals content and solvents, requirements for low VOC content levels, as well as product recyclability. HP is the only printing company to have Ecologo® Certified inks.

Greenguard Gold Certification

A prominent, voluntary third-party certification issued by UL and recognised worldwide. UL Greenguard Gold Certification to UL 2818 demonstrates that products are certified to UL Greenguard standards for low chemical emissions into indoor air during product usage. UL Greenguard Gold Certification indicates that products, including inks, printed substrates, and the combination of both for indoor applications, contribute to healthy indoor environments by minimizing potential exposure to airborne chemicals.

HP In Action

- HP Named to DJSI World Index, FSTE4Good, CDP Climate A List, and EcoVadis CSR Ratings
- Sourced 550,000 pounds of ocean-bound plastic to make new HP ink cartridges
- Committed to achieving 100% renewable electricity usage in global operations
- Pledged to enable better learning outcomes for more than 100M people by 2025
- First to publish supply chain responsibility code of conduct and industry-leading standards