

# Ecoustic<sup>®</sup> Torque

—  
An acoustic modular wall tile that provides  
excellent broadband sound absorption



INSTYLE

# Ecooustic® Torque Wall Tile

Front View

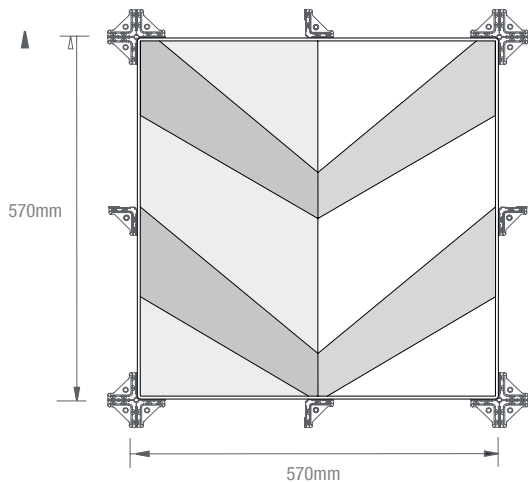

Side View

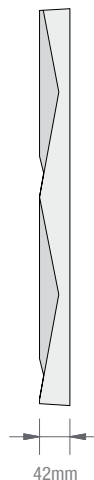

PRODUCT	Ecooustic® Torque Wall Tile
DESCRIPTION	Ecooustic® Torque is an acoustic modular tile that provides excellent broadband sound absorption in wall applications
OPTIONS	Ecooustic® Infill increases acoustic performance by 30%
DIMENSIONS	570mm (w) x 570mm (h) x 42mm (d)
ACOUSTIC	$\alpha_w$ 0.5 / NRC 0.6 $\alpha_w$ 0.75 / NRC 0.8 (Ecooustic® Infill)

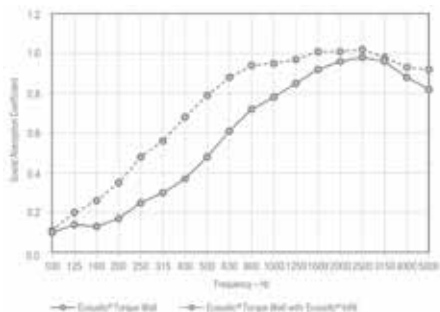

FIRE TEST		
AS/NZS 1530.3	Ignitability	9
	Spread of Flame	0
	Heat Evolved	3
	Smoke Developed	6

GB8624-2012 Grade B1

APPLICATION wall + ceiling (must be glued)

ORIGIN Made in Australia

Please contact your representative for CAD drawings

## BENEFITS

**Lightweight, Easy to Handle + Install:** Position the 4-way clips using the template provided, then simply press the tile into place. The design can be easily extended at a later stage.

### Designed for the Environment

- Based on low energy manufacturing
- 100% polyester (up to 23% PC + PI recycled content)
- Designed for disassembly + recyclable
- Low-VOC, EPD + Greentag Level A Certified

**Warranty:** A 12 month warranty is provided against manufacturing defects. Internal installation only, outdoor use will void any warranty.

**Building Rating Systems:** Torque will contribute the following points for Green Star, LEED + WELL building standards.

Criteria	Green Star	LEED	WELL
Recycled Content	✓	✓	NA
Low VOC	✓	✓	✓
Recycling Program	✓	✓	NA
EPD	✓	✓	NA
Third Party Greentag Level A Certification	✓	✓	✓
Toxic Material Reduction	NA	NA	✓
Sound Reducing Surfaces	NA	NA	✓

## HOW TO SPECIFY

DESIGN	Ecooustic® Torque Wall Tile
COLOUR	Select from Ecooustic® Felt colours
ECOUSTIC® INFILL	Optional extra - order separately

# Ecoustic® Torque Components

## Screws

Flat-head c/sunk 25mm (1") 10g  
[ 2 per 4-way clip ]  
Not supplied

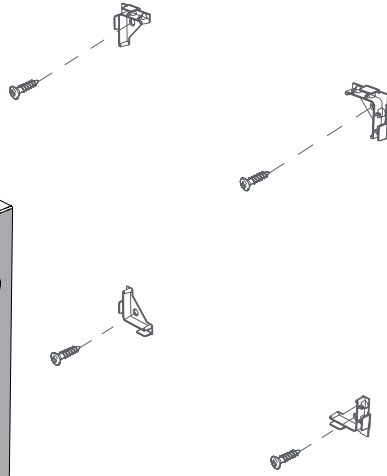
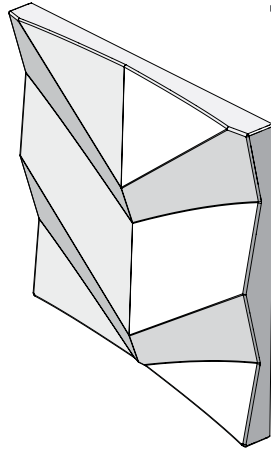

## Ecoustic® Torque Tile

100% polyester (up to 23% recycled content)  
8 tiles per box in a single colour



## 4 way clip

Clear ABS  
16 + 1 spare 4-way clips are supplied with each box  
Single clip template is included in each box

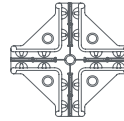

### Complete

Use a complete clip for each junction of 4 tiles

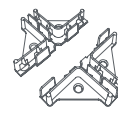

### Half

Break a clip in half for each straight edge 2 tile joins

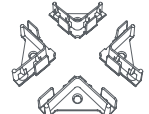

### Quarter

Break clip into quarters for each single tile corner

## Example 2280 x 2280mm Clip Layout

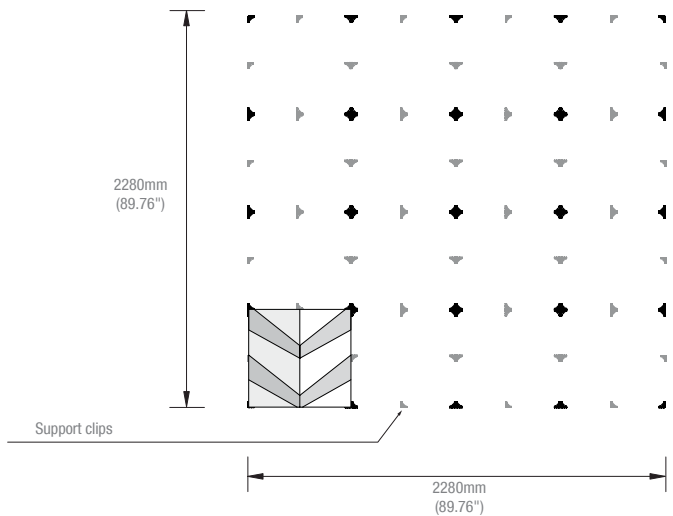

Product may vary in colour due to the nature of the media  
Please refer to website for current colour range  
Variation in fibre mix and colour is an inherent feature of this product and variation from batch to batch may occur